

TOP-V8/RGBW

Control unit for RGB and RGBW LEDs with voltage, 12-36 VDC,
max. 8A x channel (max total 24A).
RX radio 433.92 MHz, 3 wired inputs, input for extender

NEXTA
T E C H



INDEX

1 - PRODUCT FEATURES

- 1.1 - TECHNICAL DATA
- 1.2 - DESCRIPTION

2 - ELECTRICAL CONNECTION

- 2.1 - CONNECTION DIAGRAM
- 2.2 - DESCRIPTION OF CONNECTIONS

3 - USE OF THE CONTROL UNIT

- 3.1 - USE VIA RADIO
- 3.2 - USE VIA WIRE

4 - CONTROL UNIT SETTINGS

- 4.0 - SELECTION OF TYPE OF LOAD CONNECTED
- 4.1 - RADIO PROGRAMMING OF MULTIFUNCTIONAL AND GENERIC TRANSMITTERS
- 4.2 - DELETION OF RADIO
- 4.3 - "SAVE" FUNCTION (BRIGHTNESS LEVEL AND COLOUR AT SWITCH-ON)
- 4.4 - FADE SETTING: GRADUAL SWITCH-ON
- 4.5 - FADE SETTING: GRADUAL SWITCH-OFF
- 4.6 - LOAD STATE WHEN THE CONTROL UNIT IS SWITCHED ON
- 4.7 - TIMED ON
- 4.8 - FACTORY SETTINGS, RESET CONTROL UNIT

5 - FURTHER DETAILS

- 5.1 - "SAVE COLOR" FUNCTION
- 5.2 - "SOFT OFF 1 HR" FUNCTION: FADE OFF
- 5.3 - "ADJUST WHITE LIGHT TEMPERATURE" FUNCTION
- 5.4 - BEHAVIOUR OF THE "COLOR CYCLE"

1 - PRODUCT FEATURES

1.1 TECHNICAL DATA

Power supply	12-36 Vdc
Output	Max load 8 A for channel (max total 24A)
Type of load	LED with constant voltage: RGB RGB + white light RGBW
N° of programmable transmitters	30
Radio frequency	433.920mhz ISM
Protection rating	IP20
Operating temperature	-20 +55 °C
Dimensions	174x46x35 mm

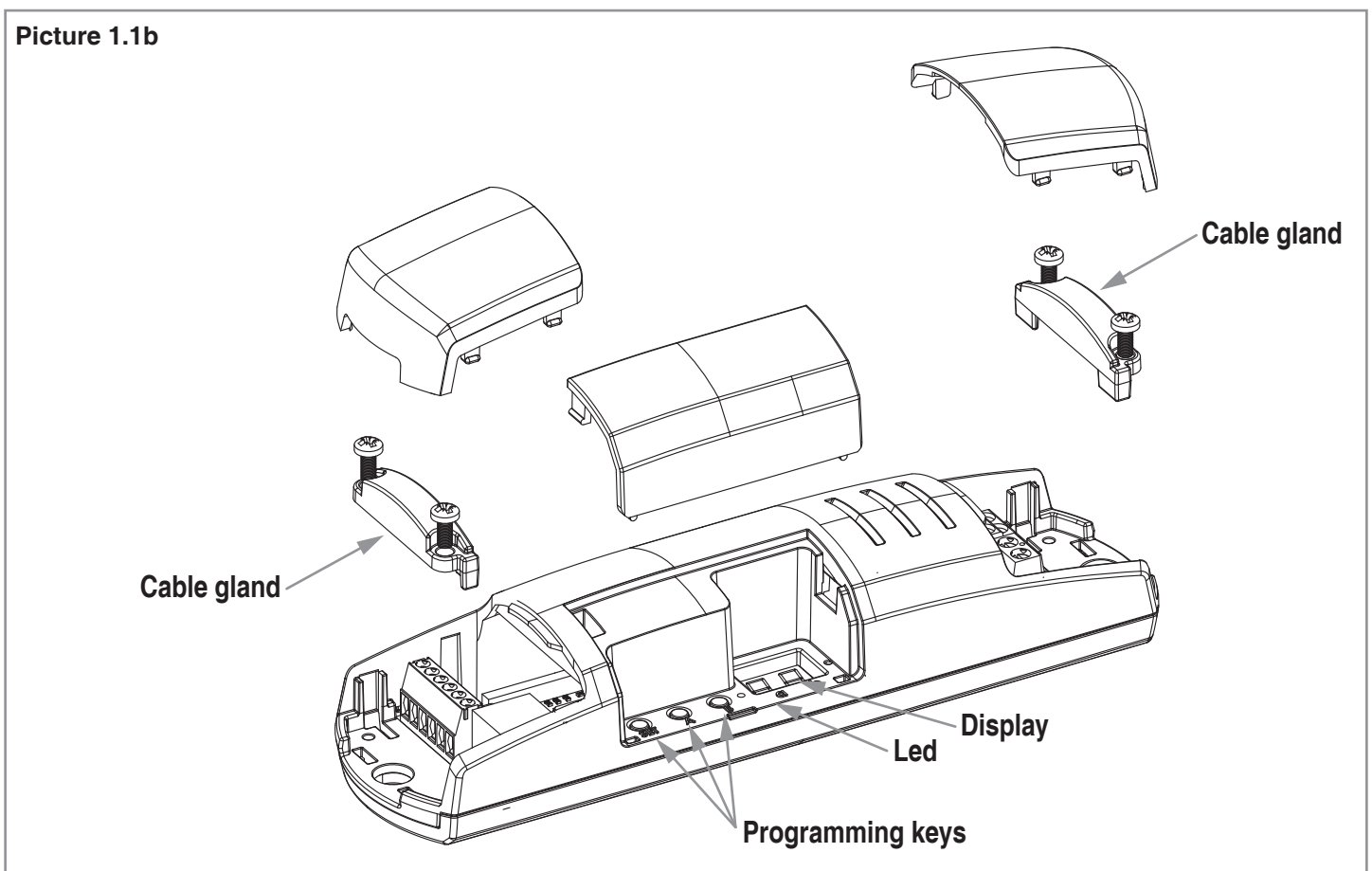
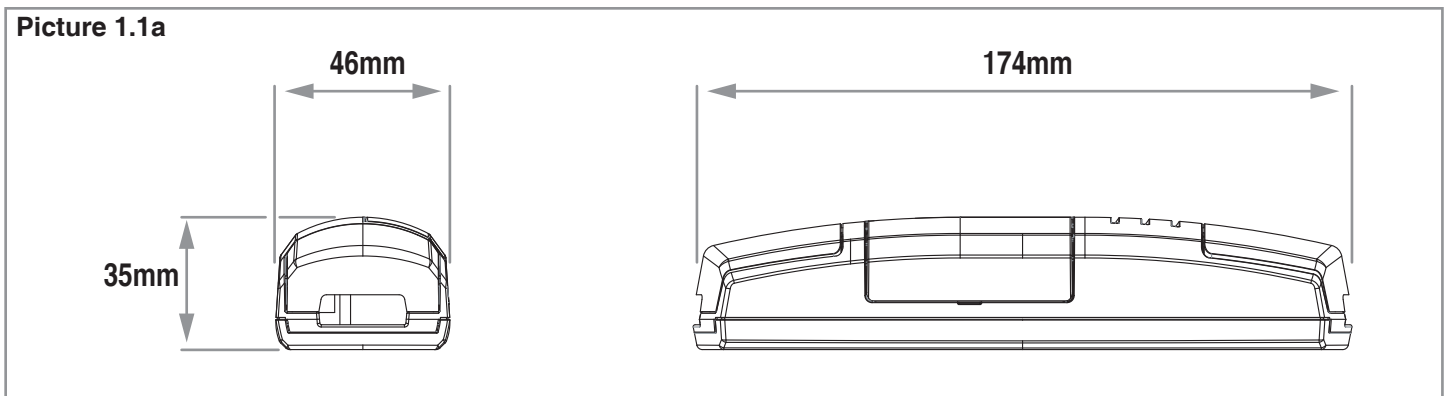

1.2 DESCRIPTION

Top-V8/RGBW is the electronic control unit for wireless and wired control of RGB and RGBW LEDs with constant voltage of 12/24/36 VDC and maximum output consumption of 8 A. The option to connect up to 4 further extender-slaves enables synchronised control of high powers. The addition of the white channel allows improved regulation of the colour temperature as well as accurate definition of white light.

Light scenarios of great effect can be achieved thanks to being able to set the fade on and off, the accurate dimming of the brightness and the chromatic effects achieved with the adjustable speed animation cycle. The ISM (industrial, scientific and medical) radio frequency band guarantees a long range, even through walls and ceilings. Programming via the display is quick and intuitive while its compact size means it can be easily installed in false ceilings (see pic. 1.2b) and interconnection boxes (see pic. 1.2c).

Pic. 1.2a

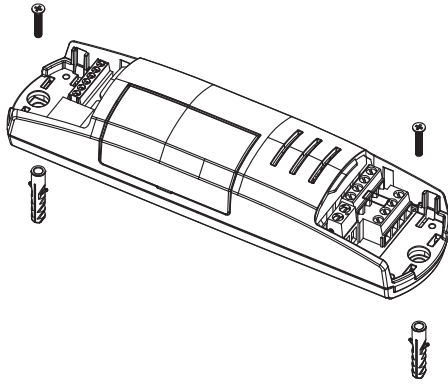

Pic. 1.2b

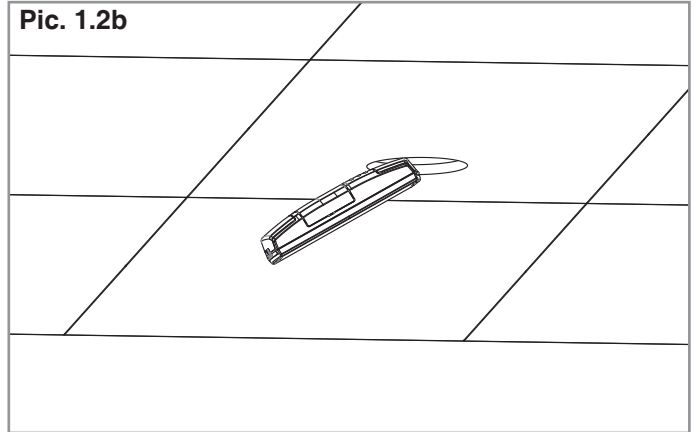

Pic. 1.2c

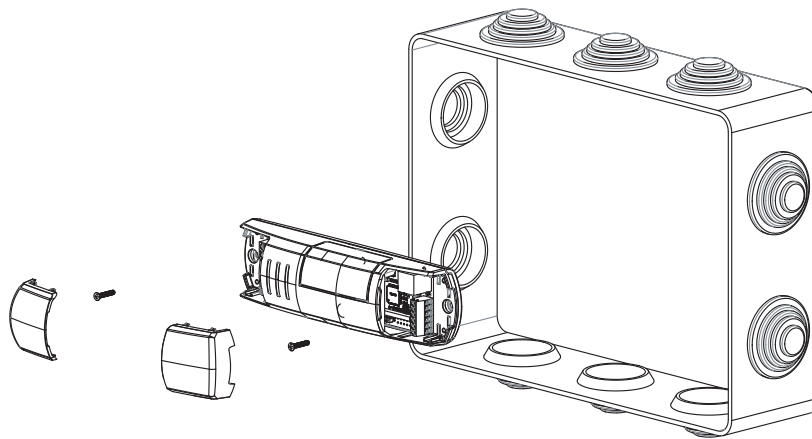

Pic. 1.2d

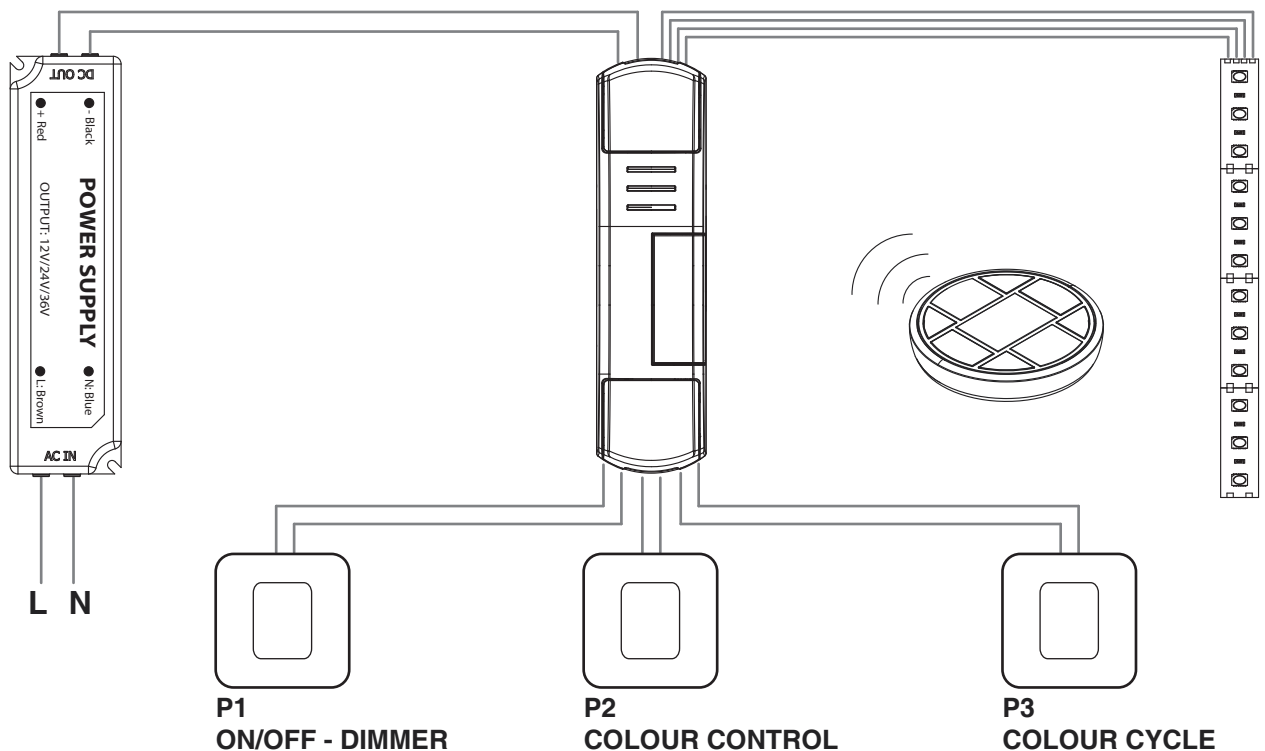

2 ELECTRICAL CONNECTIONS

2.1 CONNECTION DIAGRAM

Picture.2.1

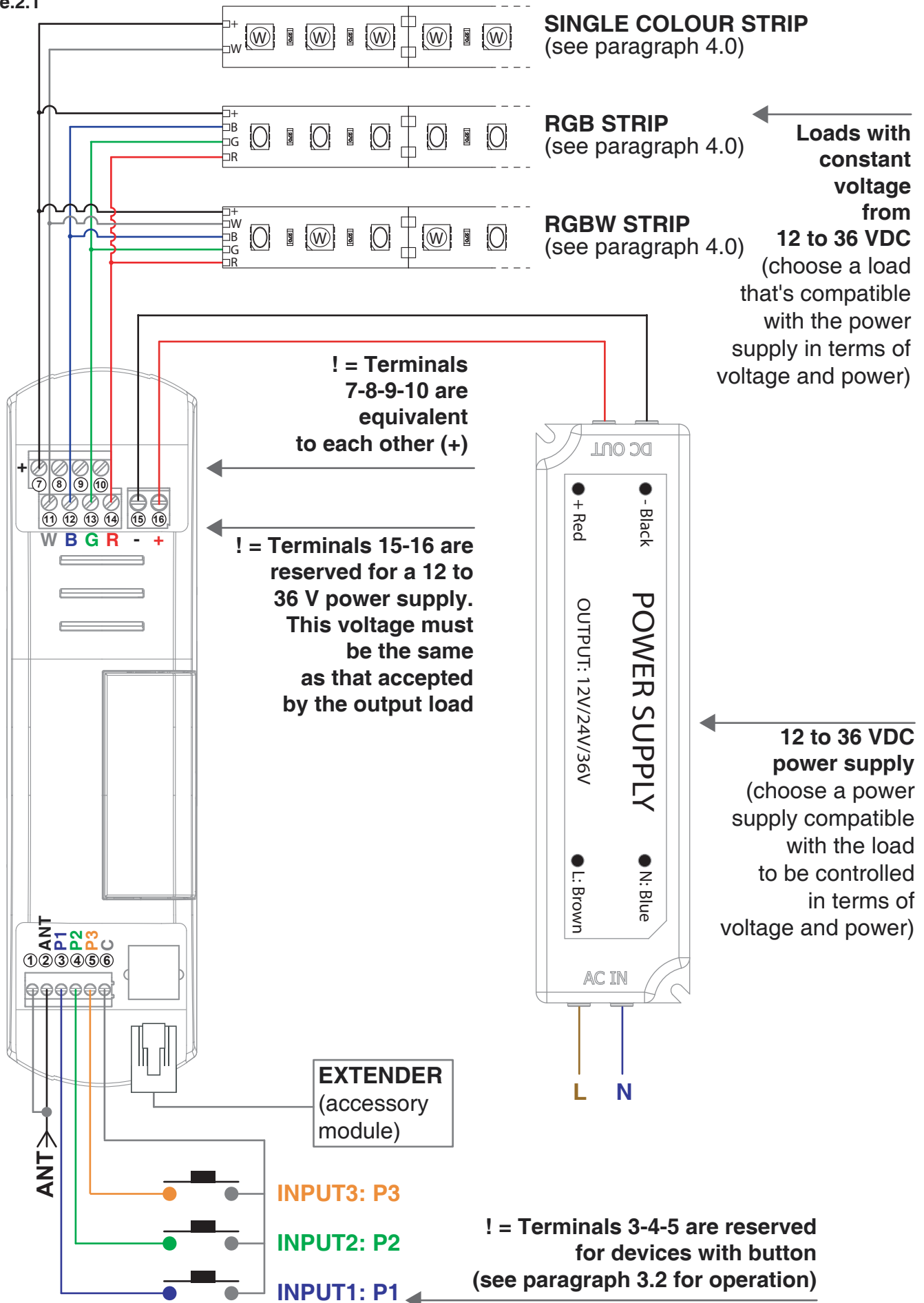

NOTE: multiple buttons or loads can be connected by using parallel cabling.

2.2 DESCRIPTION OF CONNECTIONS

- The control unit is set up to control:
 - an RGBW load (terminals 11, 12, 13 and 14)
 - an RGB load (terminals 12, 13 and 14)
 - an RGB load (terminals 12, 13 and 14) + a single colour load (terminal 11)
 - a single colour load (terminal 11)
- Use wires with a suitable cross-section for the load connected.
- Multiple buttons can be connected by using parallel cabling.
- Multiple loads can be connected to the same output by using parallel cabling.
- For ease of connection terminals 7-8-9 and 10 are equivalent to each other. The positive of each possible load can therefore be connected to a different terminal.

TERMINAL	DESCRIPTION
1	Aerial sleeve
2	Aerial signal
3	Button P1 input
4	Button P2 input
5	Button P3 input
6	Common for buttons
7, 8, 9, 10	Output +
11	Output "W"
12	Output "B"
13	Output "G"
14	Output "R"
15	Power supply -
16	Power supply + (12-24-36 V)

WARNING: If a load with higher consumption than that allowed (see control unit information plate data) is connected, the control unit will go into safety mode, switching off the load for one minute.

3 USE OF THE CONTROL UNIT

3.1 USE VIA RADIO

To control the loads via radio you must have compatible transmitters and therefore must carry out the association procedure; see paragraph 4.1.

The transmitter's control modes depend on the transmitter model used.

If the transmitter is of a generic type, its operation depends on the way it is programmed (see paragraph 4.1, table 4.1c).

If the transmitter is multifunctional, refer to the transmitter manual, to the paragraph entitled "commands sent by the transmitter", bearing in mind that it is an "RGBW" device.

3.2 USE VIA WIRE

The device is set up to accept commands via wire by button in terminals 3, 4 and 5. Should you want to control the load only via radio, it is not necessary to connect these devices for the control unit to work properly. The behaviour of the different keys is shown in the following table:

	LOAD OFF	LOAD ON
INPUT P1: short pressure	Load on	Load off
INPUT P1: long pressure	Dimmer intensity up	Dimmer intensity up / Dimmer intensity down
INPUT P2: short pressure	No action	Change of colour (white, light yellow, light green, dark green, light blue, blue, violet, light violet, pink, red, orange, light orange, yellow)*
INPUT P2: long pressure	Dimmer colour: moves gradually between all the colours. When the key is released, the load stops on the colour displayed	Stores the colour and the intensity with which the load is set (see paragraph 5.1)
INPUT P3: short pressure	No action	Play / stop "colour cycle" (see paragraph 5.4) On each prolonged pressure of the key the load will: flash once= play "colour cycle" flash twice= stop "colour cycle"
INPUT P3: long pressure	No action	Adjust duration of "colour cycle" (see paragraph 5.4) On each prolonged pressure of the key the load will: 1 flash= 90 second "colour cycle" 2 flashes= 15 minute "colour cycle"

* WARNING: the actual colour might be subject to slight variation depending on the load connected.

4 CONTROL UNIT SETTINGS

In the programming zone (see picture 4) you can access the programming menu using the keys and the display. Short presses on the "SET" key let you scroll through the different programmable functions visible on the display ("P1", "P2",,,). Prolonged pressure on the "SET" key (approx. 3 seconds) takes you to the menu for the function selected.

The different types of programming available are:

- "P0": choice of type of load connected: RGB strip or RGBW strip
- "P1": programming of radio
- "P2": deletion of radio
- "P3": activation/deactivation of memory of last value at switch-on
- "P4": selection of fade on
- "P5": selection of fade at switch-off
- "P6": load state when the control unit is switched on
- "P7": timed on
- "FS": factory setting, reset control unit

After 60 seconds' inactivity (no keys pressed), the control unit goes into stand-by with the displays switched off.

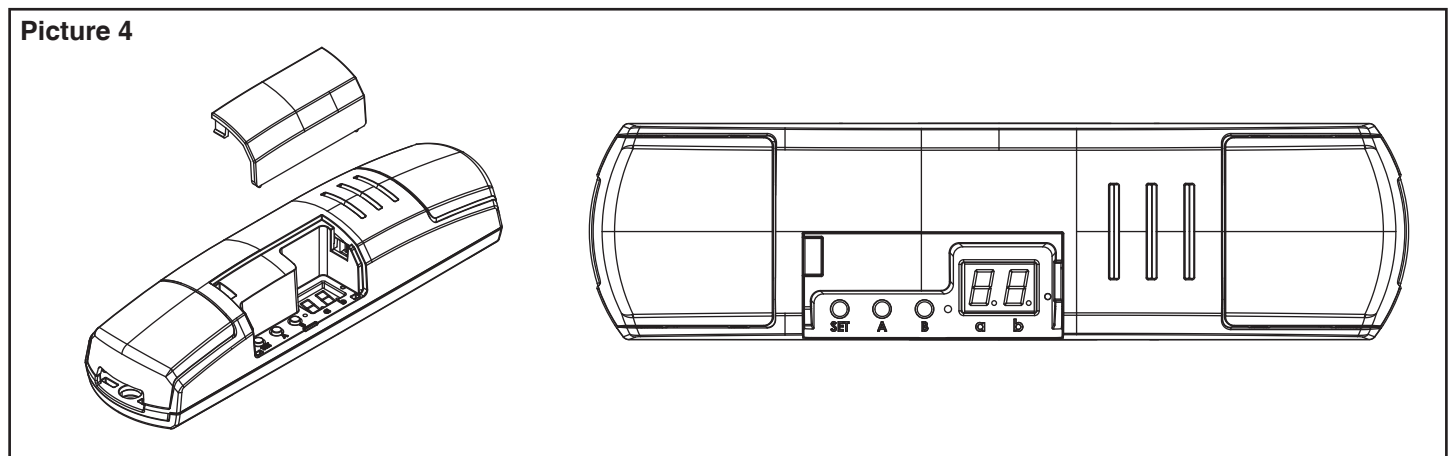

4.0 MENU "P0": SELECTION OF TYPE OF LOAD CONNECTED: "RGB", "RGBW MODE 1" OR "RGBW MODE 2"

Default: RGB mode

This procedure is used to set up the type of control of load.

The three types are:

1 - RGB: in this case to create white light the control unit will use the three output channels "R", "G" and "B"

2 - RGBW modo 1: in this case to create white light the control unit will use the output channel "W"

3 - RGBW modo 2: in this case to create white light the control unit will use the output channel "W" and the three output channels "R", "G" and "B". This is to obtain the maximum available light.

PROCEDURE:

STEP 1

Short presses on the "SET" key let you scroll through the menu until "P0" programming appears on the display.

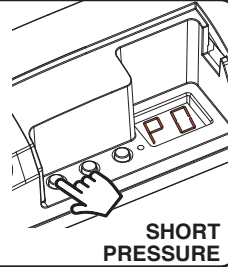

STEP 2

A prolonged press on the "SET" key (approx. 3 seconds) takes you into programming.

The LED on the receiver lights up

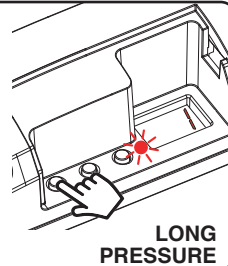

STEP 3

Short presses on key "B" let you choose the function you want to programme shown on the displays based on what is shown in the table alongside

DISPLAY	TYPE OF CONTROL
1	RGB
2	RGBW MODE 1
3	RGBW MODE 2

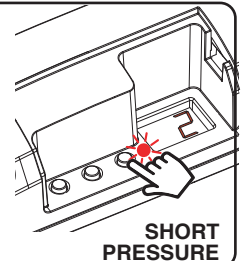

STEP 4

To confirm give a long press on the "SET" key (approx. 3 seconds).

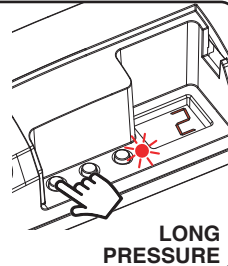

STEP 5

The control unit goes back to the menu displaying the different types of programming.

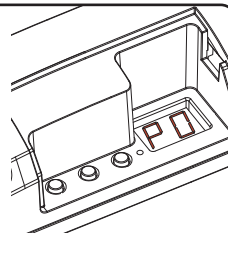

Attention:

- the temperature (hot or cold) and quality of white depend on the strip attached.
- the RGBW settings are reserved for loads that also have the white channel (e.g. RGBW LED strips) or when an additional single colour strip is connected (connected in "W" output).

4.1 MENU "P1": RADIO PROGRAMMING

This procedure lets you programme compatible multifunctional or generic transmitters.

WHICH REMOTE CONTROL DO YOU WANT TO ASSOCIATE WITH THE CONTROL UNIT?

MULTIFUNCTIONAL TRANSMITTERS

CODES:

HB70-SLCT, HB70-SPCT,
HB80-1C, HB80-1DIM, HB80-2L, HB80-30D, HB80-30RGBW, HB80-4C, HB80-4DIM, HB80-4L,
HB90-6LT,
ROUND-1SP,
SENSA-M, SENSA-P, SENSA-R35M, SENSA-R35P, SENSA-R35T, SENSA-T,
TOUCH-1, TOUCH-1CCT, TOUCH-1DIM, TOUCH-1SP, TOUCH-1L, TOUCH-1RGBW, TOUCH-3C, TOUCH-4DIM, TOUCH-CFU

With multifunctional transmitters the transmitter control modes depend on the model used.
Refer to the transmitter manual, to the paragraph entitled "commands sent by the transmitter", bearing in mind that it is an "RGBW" device.

GENERIC TRANSMITTERS (WIRELESS BUS)

CODES:

HB80-6G,
MCU-TX4,
TOUCH-1G, TOUCH-2G, TOUCH-4G, TOUCH-LOCK4, TOUCH-TX2,
ROUND-1G

With generic transmitters, the transmitter's control modes depend on the function associated with the key during the association procedure.

The available function for the key are:

TABELLA 4.1 - KEY FUNCTIONS OF THE GENERIC TRANSMITTER

NUMBER TO BE SET IN "STEP 3b" OF THE PROCEDURE	KEY FUNCTION
2	Short press: ON/OFF Prolonged press: Dimmer intensity UP / DOWN
3	ON
4	OFF
5	Dimmer intensity UP
6	Dimmer intensity DOWN
7	Short press: with light on it changes colour Prolonged press: with light off dimmer colour / with light on save colour (see paragraph 5.1)
8	Dimmer intensity UP shade of colour
9	Dimmer intensity DOWN shade of colour
10	Play / stop "colour cycle" (see paragraph 5.4)
11	Change effect of "colour cycle" (see paragraph 5.4)
12	Change duration of "colour cycle" (see paragraph 5.4)
13	Deactivate "save colour" (see paragraph 5.1) "Soft Off 1h":
14	"Soft Off 1 hr": gradual fading in one hour (see paragraph 5.2)

PROCEDURE

STEP 1

Short presses on the "SET" key let you scroll through the menu until "P1" programming appears on the display.

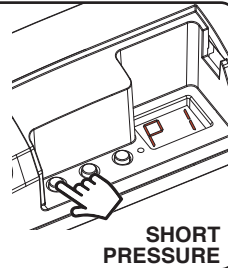

STEP 2

A prolonged press on the "SET" key (approx. 3 seconds) takes you into programming.

The LED on the receiver comes on

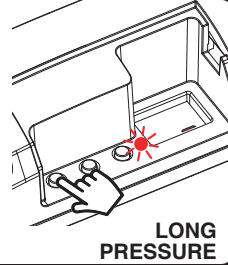

WHICH TRANSMITTER DO YOU WANT TO PROGRAMME?

MULTIFUNCTION TRANSMITTER
(see models and codes on previous page)

GENERIC TRANSMITTER
(see models and codes on previous page)

STEP 3a

Short presses on key "B" let you set value "1" on the display

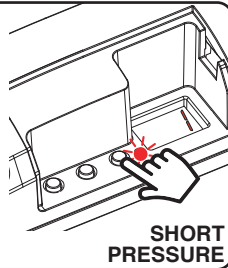

STEP 3b

Short presses on key "B" let you choose the function you want to programme shown on the displays. See table 4.1 on the previous page.

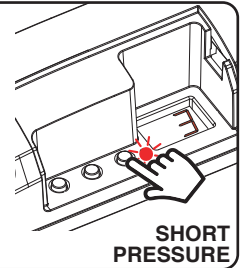

STEP 4

Give a long press on key "B" (approx. 3 seconds).

The LED on the display comes on

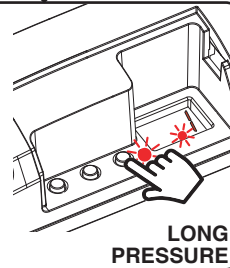

STEP 5

Make a transmission with the transmitter to be saved (see transmitter manual, the paragraph entitled "transmitter programming").

The LED on the receiver flashes 3 times to signal that it has been received.

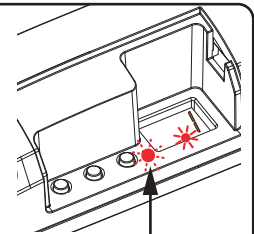

STEP 6

The control unit listens for 50 seconds in case you want to add other transmitters. To immediately exit the procedure give a short pressure on key "b".

The LED on the display turns off

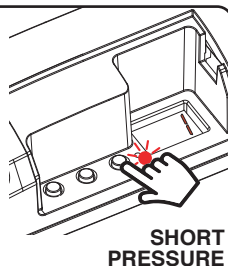

STEP 7

The control unit goes back to the menu displaying the radio programming. If you want to save other transmitters, go back to point 3 of this procedure.

If you want to go back to the menu displaying the different types of programming, give a prolonged press to the "SET" key (approx. 3 seconds).

4.2 MENU "P2": DELETION OF RADIO

These procedures let you delete transmitters that have already been programmed from the receiver's memory.

DELETION OF SINGLE TRANSMITTER CHANNEL:

STEP 1

Short presses on the "SET" key let you scroll through the menu until "P2" programming appears on the display.

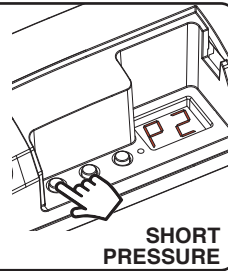

STEP 2

A prolonged press on the "SET" key (approx. 3 seconds) takes you into programming.

The LED on the receiver lights up

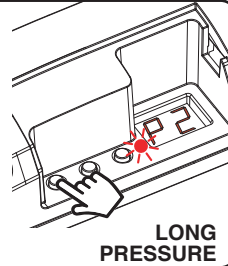

What is shown on display "a" and "b" has no influence on this procedure.

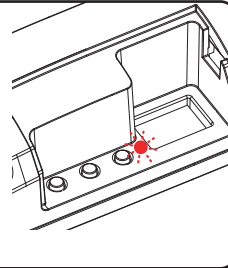

STEP 3

Give a long press on key "B" (approx. 3 seconds)

The LED on the receiver starts to flash

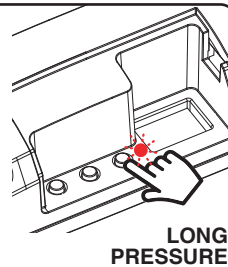

STEP 4

Within 5 seconds make a transmission with the remote control that you want to delete.

The LED on the receiver will flash rapidly and stay on



MAKE A TRANSMISSION WITH THE TRANSMITTER

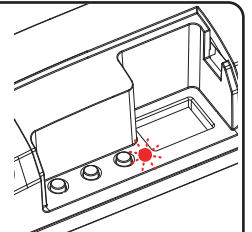

STEP 5

The control unit goes back to the menu displaying the radio deletion. If you want to delete other transmitters, go back to point 3 of this procedure.

If you want to go back to the menu displaying the different types of programming, give a prolonged press to the "SET" key (approx. 3 seconds).

DELETION OF ALL THE SAVED TRANSMITTERS:

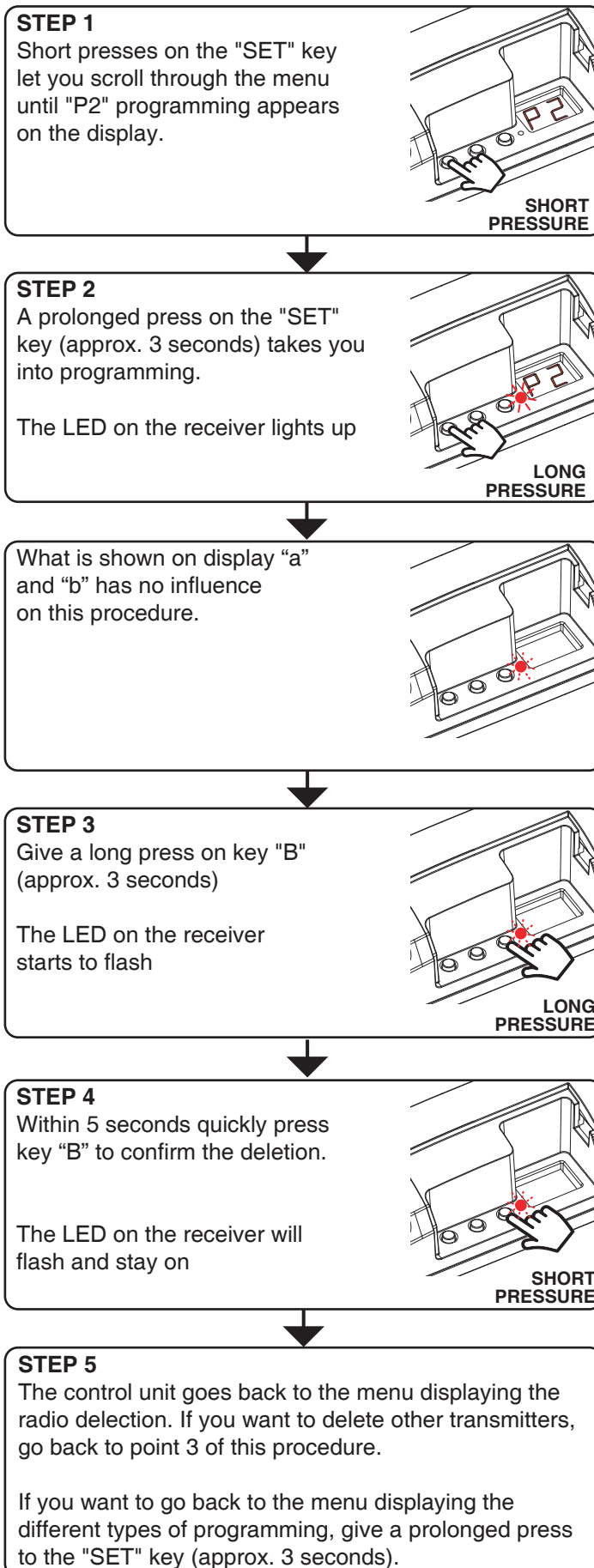

4.3 MENU "P3": "SAVE" FUNCTION: (BRIGHTNESS LEVEL AND COLOUR AT SWITCH-ON)

Default: switches on with white light at maximum brightness

With this procedure you can set the intensity value at which the load switches on.

PROCEDURE:

STEP 1
Short presses on the "SET" key let you scroll through the menu until "P3" programming appears on the display.

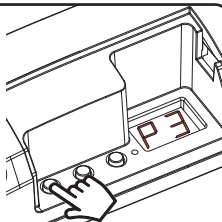

SHORT PRESSURE

STEP 2
A prolonged press on the "SET" key (approx. 3 seconds) takes you into programming.

The LED on the receiver lights up

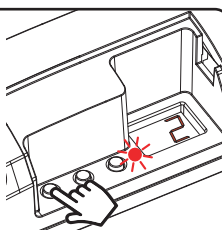

LONG PRESSURE

STEP 3
Make short presses on key "B" to choose the setting you want to set based on table alongside

DISPLAY	SAVE FUNCTION: INTENSITY AT SWITCH-ON
1	"SAVE" function on. The load will switch on at the last brightness value and colour set before it was switched off
2	Switch-on of load at maximum intensity with white light
3	Switch-on at value saved (see paragraph 5.1)

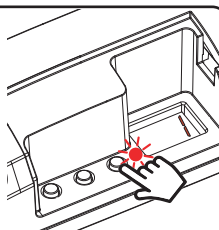

SHORT PRESSURE

STEP 4
To confirm give a prolonged press on the "SET" key (approx. 3 seconds).

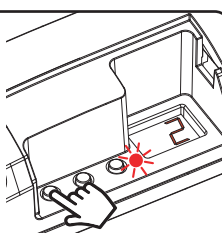

LONG PRESSURE

STEP 5
The control unit goes back to the menu displaying the different types of programming.

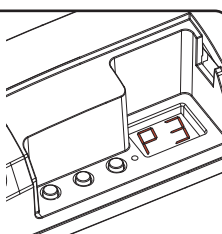

WARNING: The setting of display "b"=3 is possible only if a store colour command was previously sent by transmitter or via wire, see paragraph 5.1.

4.4 MENU "P4": FADE SETTING: GRADUAL SWITCH-ON

Default: switch-on in approx. 0.5

This procedure means you can set the duration of the switch-on time.

PROCEDURE:

STEP 1

Short presses on the "SET" key let you scroll through the menu until "P4" programming appears on the display.

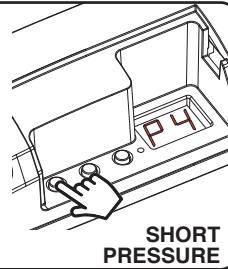

STEP 2

A prolonged press on the "SET" key (approx. 3 seconds) takes you into programming.

The LED on the receiver lights up

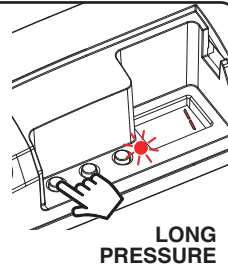

STEP 3

Make short presses on key "B" to choose the setting you want to set based on table alongside

DISPLAY	FADE: FADE ON TIME
—	immediate ON
01	ON ~ 0,5s
02	ON ~ 2s
03	ON ~ 4s
04	ON ~ 10s

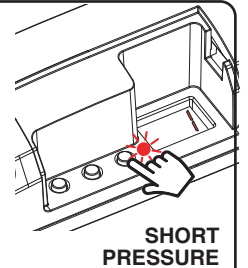

PASSO 4

To confirm give a prolonged press on the "SET" key (approx. 3 seconds).

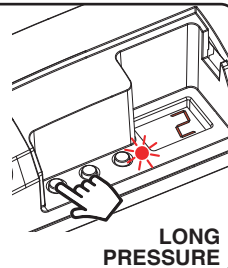

PASSO 5

The control unit goes back to the menu displaying the different types of programming.

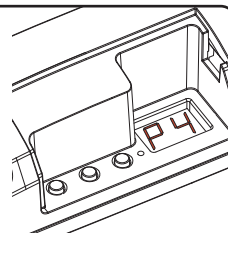

4.5 MENU "P5": FADE SETTING: GRADUAL SWITCH-OFF

Default: switch-off in approx. 0.5 seconds

This procedure means you can set the duration of the switch-off time.

PROCEDURE:

STEP 1
Short presses on the "SET" key let you scroll through the menu until "P5" programming appears on the display.

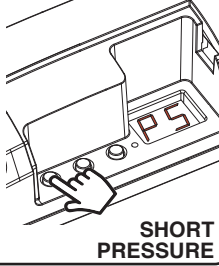

SHORT PRESSURE

STEP 2
A prolonged press on the "SET" key (approx. 3 seconds) takes you into programming.
The LED on the receiver lights up

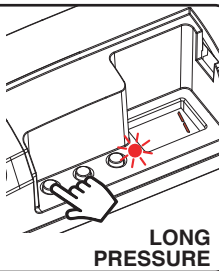

LONG PRESSURE

STEP 3
Make short presses on key "B" to choose the setting you want to set based on table alongside

DISPLAY	FADE: FADE OFF TIME
—	immediate OFF
01	OFF ~ 0,5s
02	OFF ~ 2s
03	OFF ~ 4s
04	OFF ~ 10s

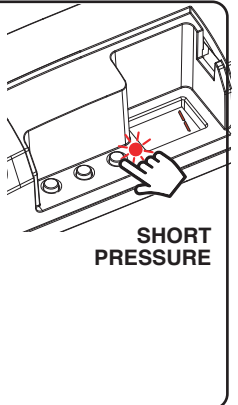

SHORT PRESSURE

PASSO 4
To confirm give a prolonged press on the "SET" key (approx. 3 seconds).

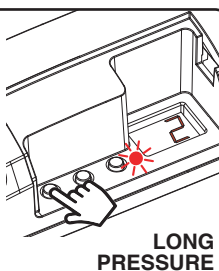

LONG PRESSURE

PASSO 5
The control unit goes back to the menu displaying the different types of programming.

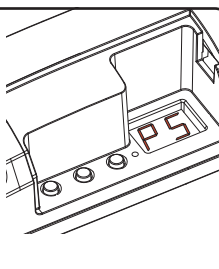

4.6 MENU "P6": LOAD STATE WHEN THE CONTROL UNIT IS SWITCHED ON

Default: Light Off

This process is used to set the state of Leds when the control unit is switched on (for example when the power supply is provided by a general switch or timer).

PROCEDURE:

STEP 1

Short presses on the "SET" key let you scroll through the menu until "P6" programming appears on the display.

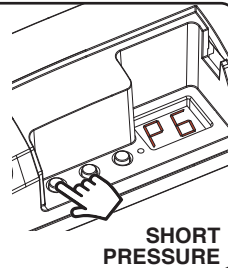

STEP 2

A prolonged press on the "SET" key (approx. 3 seconds) takes you into programming.

The LED on the receiver lights up

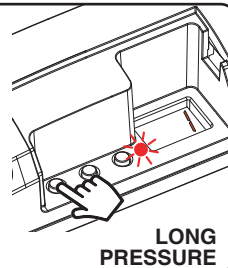

STEP 3

Short presses on key "B" let you choose the function you want to programme shown on the displays based on what is shown in the table alongside

DISPLAY	BRIGHTNESS AT SWITCH-ON
1	Default (light off)
2	The light switches on in the same status as the load is currently in: Set the desired status of light
3	Colour cycle

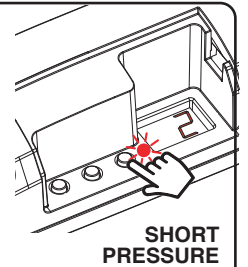

STEP 4

To confirm give a prolonged press on the "SET" key (approx. 3 seconds).

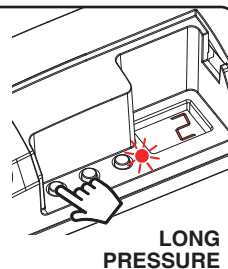

STEP 5

The control unit goes back to the menu displaying the different types of programming.

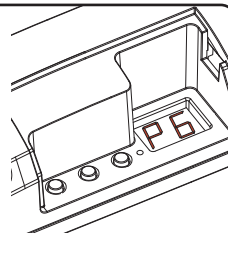

4.7 MENU "P7": TIMED ON

Default: No timing

This process is used to set the time for which the Leds stays on before an automatic switch off.

PROCEDURE:

STEP 1

Short presses on the "SET" key let you scroll through the menu until "P7" programming appears on the display.

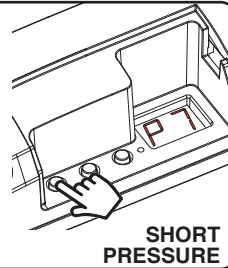

STEP 2

A prolonged press on the "SET" key (approx. 3 seconds) takes you into programming.

The LED on the receiver lights up

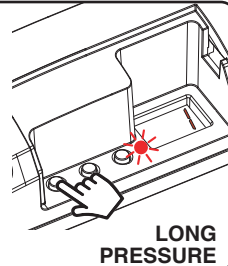

STEP 3

Short presses on key "B" let you choose the timing that you want to programme shown on the displays based on what is shown in table alongside

DISPLAY	TIMED ON
1	No Timing
2	1 minute
3	5 minutes
4	15 minutes
5	40 minutes
6	1 hour
7	2 hours
8	3 hours
9	8 hours

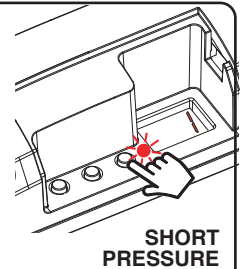

STEP 4

To confirm, give a prolonged press on the "SET" key (approx. 3 seconds).

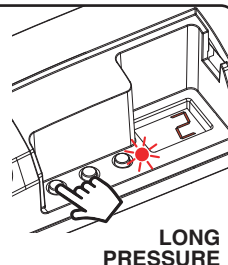

STEP 5

The control unit goes back to the menu displaying the different types of programming.

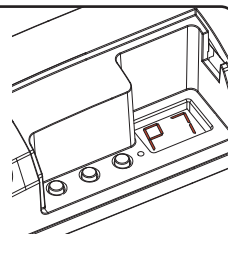

4.8 MENU "FS": FACTORY SETTING, RESET DELLA CENTRALE

This procedure let you take the control unit back to factory settings.

PROCEDURE:

STEP 1
Short presses on the "SET" key let you scroll through the menu until "FS" programming appears on the display.

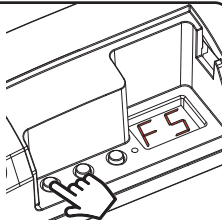

SHORT PRESSURE

STEP 2
A prolonged press on the "SET" key (approx. 3 seconds) takes you into programming.
The LED on the receiver lights up

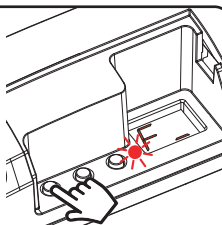

LONG PRESSURE

STEP 3
Con pressioni brevi del tasto "B" posso modificare l'impostazione visualizzata sul display "b":

display = F1	reset factory parameters, but no deletion of already programmed transmitters
display = F2	full reset of factory parameters, even stored transmitters will be deleted

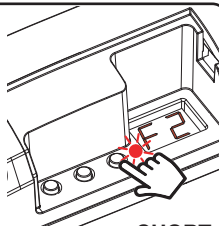

SHORT PRESSURE

STEP 4
To confirm, give a prolonged press on the "SET" key (approx. 3 seconds).
The LED flashes

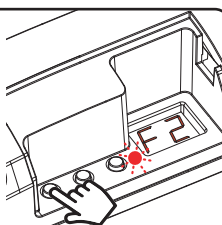

LONG PRESSURE

STEP 5
The control unit goes back to the menu displaying the different types of programming.

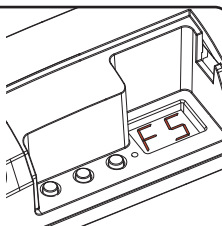

5 FURTHER DETAILS

The following paragraphs describe the ways the lights connected are commanded and controlled.

5.1 "SAVE COLOR" FUNCTION

The "save color" function enables a colour and intensity for the connected load to be saved, which can then be used every time it is switched on.

This function can be used after adjusting the colour and intensity as desired (via radio or wire);

- VIA WIRE: with a prolonged press on the button connected to input "P2" (see paragraph 3.2 for the use of buttons via wire).

- VIA RADIO WITH GENERIC TRANSMITTER: with a prolonged press on a generic transmitter (see table 4.1b) programmed with the "change color/save color" function (see table 4.1c).

- VIA RADIO WITH MULTIFUNCTIONAL TRANSMITTER: with a compatible multifunctional transmitter (see table 5.1a). The way the command is sent depends on the transmitter model used, see the transmitter manual.

Tab. 5.1a

COMPATIBLE MULTIFUNCTIONAL TRANSMITTERS
<i>HB80-30RGBW, HB80-4LRGBW, HB90-6LT</i>

After sending a "save color" command, the load will always switch on with the colour and intensity saved.

To change the switch-on value:

- another "save color" value must be sent (if you want the default value, just send the command with the load switched on with a white light and maximum intensity).

- a generic transmitter must be used (see table 4.1b), programmed with the "deactivate save color" function (see table 4.1c).

The control unit will set the switch-on value that was originally programmed (see paragraph 4.3).

- carry out the procedure described in paragraph 4.3 and set display "b" to the desired setting.

5.2 "SOFT OFF 1 HR" FUNCTION: FADE OFF

The "Soft off 1 hr" function is a gradual fading off in one hour starting from the colour and intensity set at the time the command was sent.

This function can be activated after adjusting the colour and intensity as desired (via radio or wire);

- VIA RADIO WITH GENERIC TRANSMITTER: with a generic transmitter (see table 4.1b) programmed with the "soft off 1 hr" function (see table 4.1c).

This gradual switch-off can be interrupted at any time by the sending of another command via radio or via wire.

5.3 "ADJUST WHITE LIGHT TEMPERATURE" FUNCTION

This function enables an effect on white light to be produced which makes the light warmer (by moving the shade towards red) or colder (by moving the shade towards blue).

This function can be used after adjusting the colour and intensity as desired (via radio or wire);

- VIA RADIO WITH MULTIFUNCTIONAL TRANSMITTER: with a compatible multifunctional transmitter (see table 5.3a). The way the command is sent depends on the transmitter model used, see the transmitter manual.

Tab. 5.3a

COMPATIBLE MULTIFUNCTIONAL TRANSMITTERS
<i>HB80-30RGBW, HB80-4LRGBW, HB90-6LT</i>

5.4 BEHAVIOUR OF THE "COLOR CYCLE"

The "color cycle" is an automatic and gradual changing of the colours to create an effect.

The cycle can be played/stopped by sending commands:

- VIA WIRE: with a short press on the button connected to input "P3" (see paragraph 3.2) with the light on.
 - VIA RADIO WITH GENERIC TRANSMITTER: with a generic transmitter (see table 4.1b) programmed with the "play/stop color cycle" function (see table 4.1c).
 - VIA RADIO WITH MULTIFUNCTIONAL TRANSMITTER: with a compatible multifunctional transmitter (see table 5.4a).
- The way the command is sent depends on the transmitter model used, see the transmitter manual.

With each press on one of these commands the load will:

flash once= play "color cycle"

flash twice= stop "color cycle"

CHANGE "COLOR CYCLE" DURATION

This function is used to adjust the duration of the colour cycle. At the end of the cycle with the time set it will start again from the beginning.

The duration of the cycle can be changed by sending commands:

- VIA WIRE: with a prolonged press (about 3 seconds) on the button connected to input "P3" (see paragraph 3.2) with the light on.
- VIA RADIO WITH GENERIC TRANSMITTER: with a generic transmitter (see table 4.1b) programmed with the "change color cycle duration" function (see table 4.1c).

With each press on one of these commands the load will:

flash once= short 90 second "color cycle" Default value

flash twice= long 15 minute "color cycle"

- VIA RADIO WITH MULTIFUNCTIONAL TRANSMITTER: with a compatible multifunctional transmitter (see table 5.4b).

The way the command is sent depends on the transmitter model used, see the transmitter manual.

With multifunctional transmitters other cycle duration values can be set.

After sending a "change color cycle duration" command, the cycle will always be executed with the duration set.

To change the duration of the cycle again, reset it as desired.

CHANGE "COLOR CYCLE" EFFECT

This function is used to change the shades of colour that are displayed during the cycle.

The shades that can be set are:

Effect1 (default value): the colour cycle displays all the shades

Effect2: colour cycle with green and blue tones

Effect3: colour cycle with blue and violet tones

Effect4: colour cycle with blue, violet and pink tones

Effect5: colour cycle with red and orange tones

Effect6: colour cycle with orange and yellow tones

The effect of the cycle can be changed by sending commands:

- VIA RADIO WITH GENERIC TRANSMITTER: with a generic transmitter (see table 4.1b) programmed with the "change color cycle effect" function (see table 4.1c).
- VIA RADIO WITH MULTIFUNCTIONAL TRANSMITTER: with a compatible multifunctional transmitter (see table 5.4c).

The way the command is sent depends on the transmitter model used, see the transmitter manual.

After sending a "change color cycle effect" command, the cycle will always be executed with the effect set. To change the effect of the cycle again, reset it as desired.

Tab. 5.4a

COMPATIBLE MULTIFUNCTIONAL TRANSMITTERS
<i>HB80-1C, HB80-4C, HB80-30RGBW, HB90-6LT, TOUCH-1C, TOUCH-CFU</i>

Tab. 5.4b

COMPATIBLE MULTIFUNCTIONAL TRANSMITTERS
<i>HB80-1C, HB80-4C, HB80-30RGBW, HB90-6LT, TOUCH-1C, TOUCH-CFU</i>

Tab. 5.4c

COMPATIBLE MULTIFUNCTIONAL TRANSMITTERS
<i>HB80-1C, HB80-4C, HB80-30RGBW, HB90-6LT, TOUCH-CFU</i>



MNLTOP-V8/RGBWENV1.3

Nexta Tech

company brand of Team srl
via G.Oberdan 90, 33074
Fontanafredda (PN) - Italy
Ph. +39 0434 998682
Email: info@nexta-tech.com
Web: www.nexta-tech.com