

TOP-A0307/EXT4

*Extender with constant current, 4 x 350-700mA for
"TOP-A0307/RGB" and "TOP-A0307/3".*

TOP-A0509/EXT4

*Extender with constant current, 4 x 500-900mA for
"TOP-A0509/RGB" and "TOP-A0509/3".*

NEXTA
T E C H



INDEX

1 - PRODUCT FEATURES

1.1 - TECHNICAL DATA

1.2 - DESCRIPTION

2 - ELECTRICAL CONNECTION

2.1 - CONNECTION DIAGRAM

2.2 - DESCRIPTION OF CONNECTIONS

2.3 - SET THE OUTPUT CURRENT

3 - USE OF THE CONTROL UNIT

1 - PRODUCT FEATURES

1.1 TECHNICAL DATA

Power supply	12-36 Vdc
Output	4 outputs
Type of load	LED with constant current
Connection system master/slave/slave	6-pole RJ11 cable with crossed connection
Max lenght connection	Max. total length between master and extender 50m
Protection rating	IP20
Operating temperature	-20 +55 °C
Dimensions	174x46x35 mm

Picture 1.1a

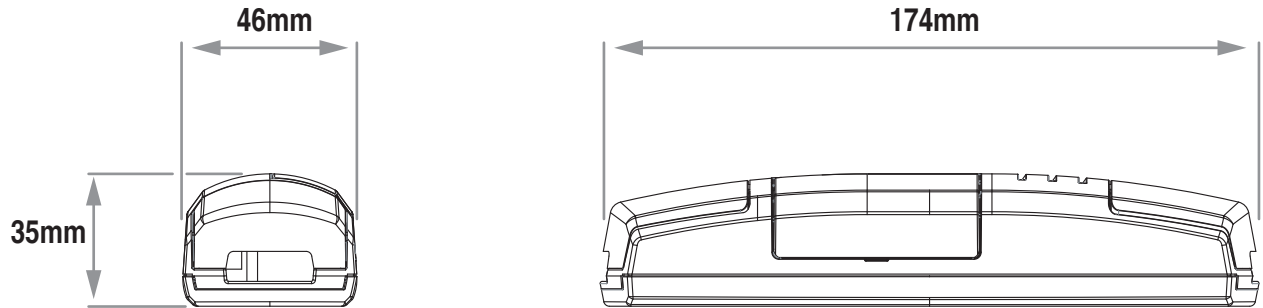

Picture 1.1b

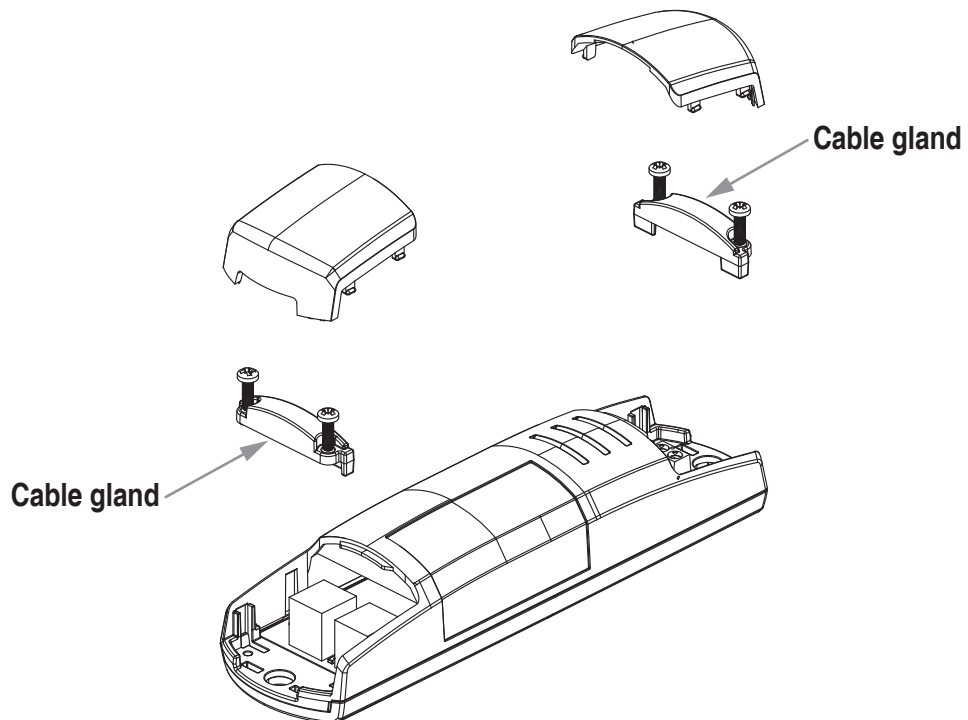

1.2 DESCRIZIONE

Electronic control unit for the repetition of commands.

TOP-A0307/EXT4: Extender with constant current, 4 x 350-700mA for "TOP-A0307/RGB" and "TOP-A0307/3".

TOP-A0509/EXT4: Extender with constant current, 4 x 500-900mA for "TOP-A0509/RGB" and "TOP-A0509/3".

Pic. 1.2a

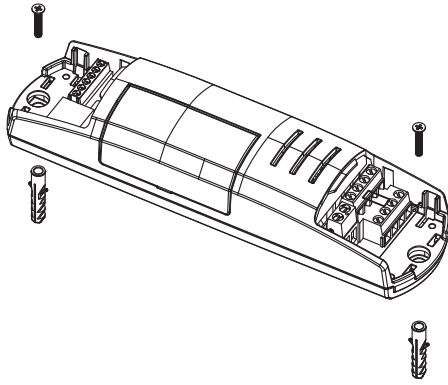

Pic. 1.2b

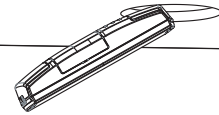

Pic. 1.2c

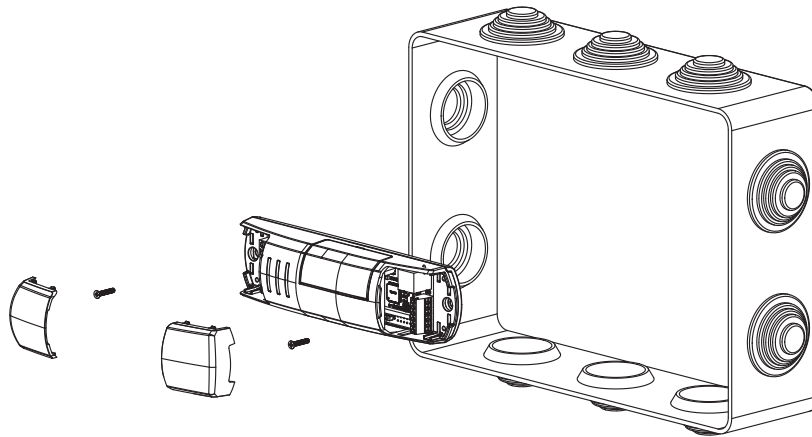

Pic. 1.2d

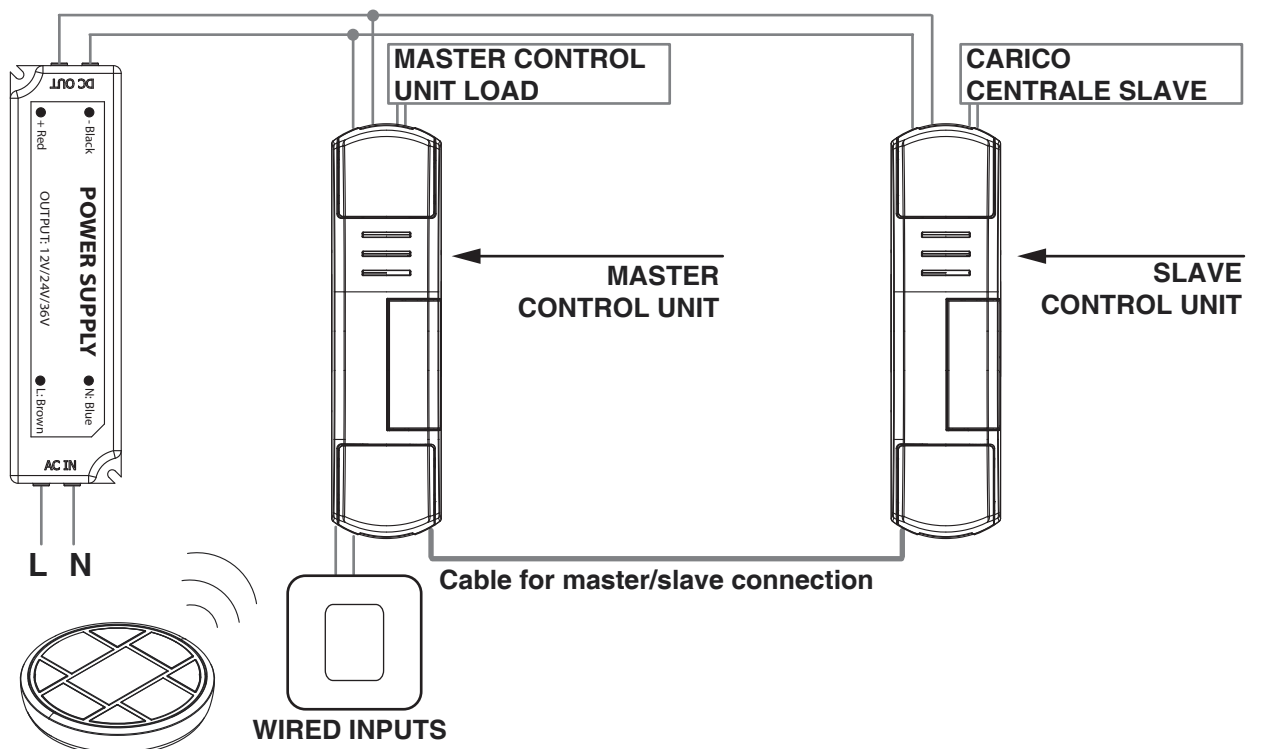

2 ELECTRICAL CONNECTIONS

2.1 CONNECTION DIAGRAM

Pic.2.1

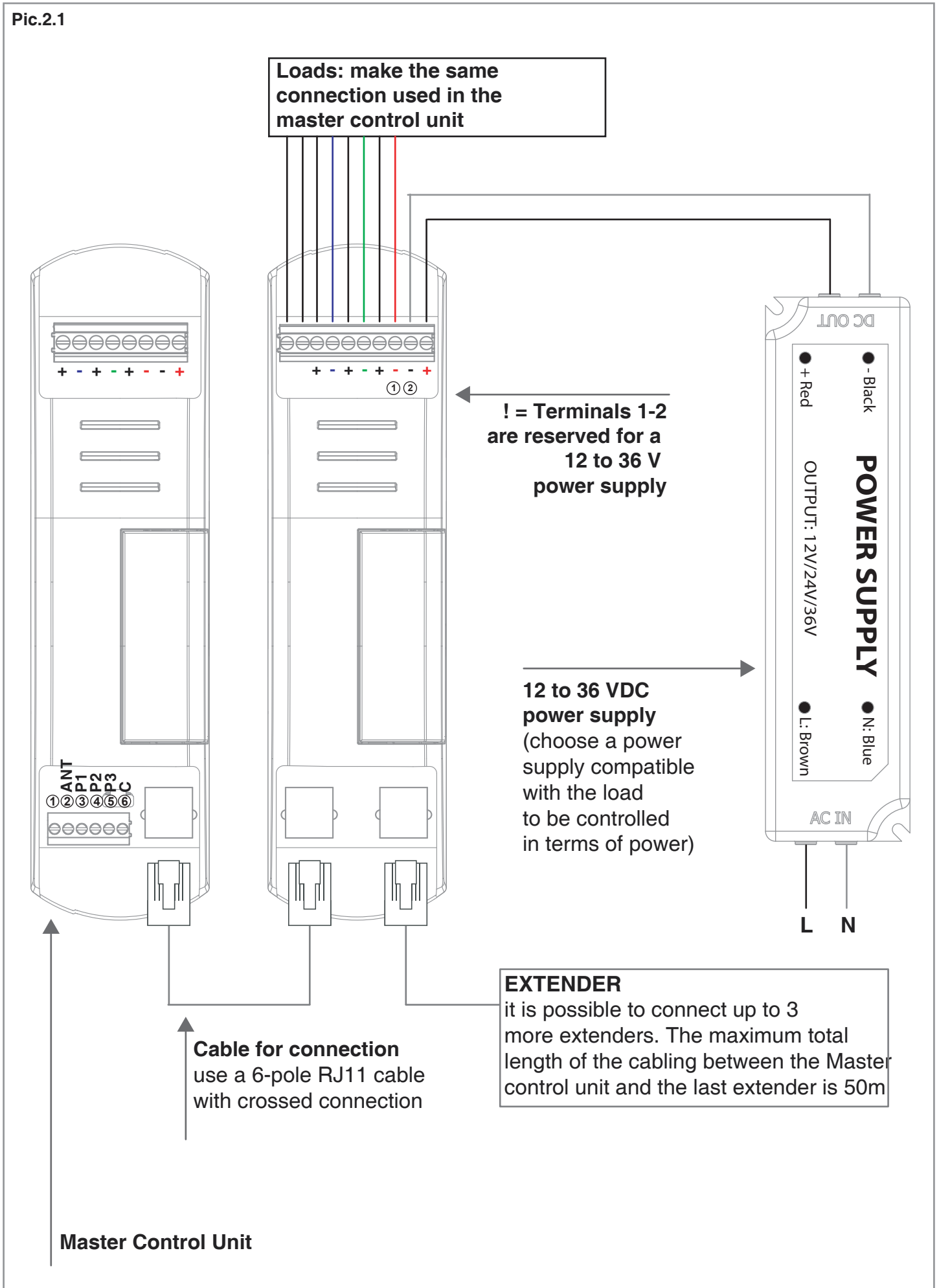

2.2 DESCRIZIONE DEI COLLEGAMENTI

For the connection of the master control unit with the slave control unit (or to connect one slave control unit to another), an RJ11 cable with crossed connection must be used (see Figure 2.2a). Up to a maximum of 4 extenders can be connected, with a total length of cabling between the master control unit and the last extender of 50m, see Figure 2.2b.

Pic.2.2a

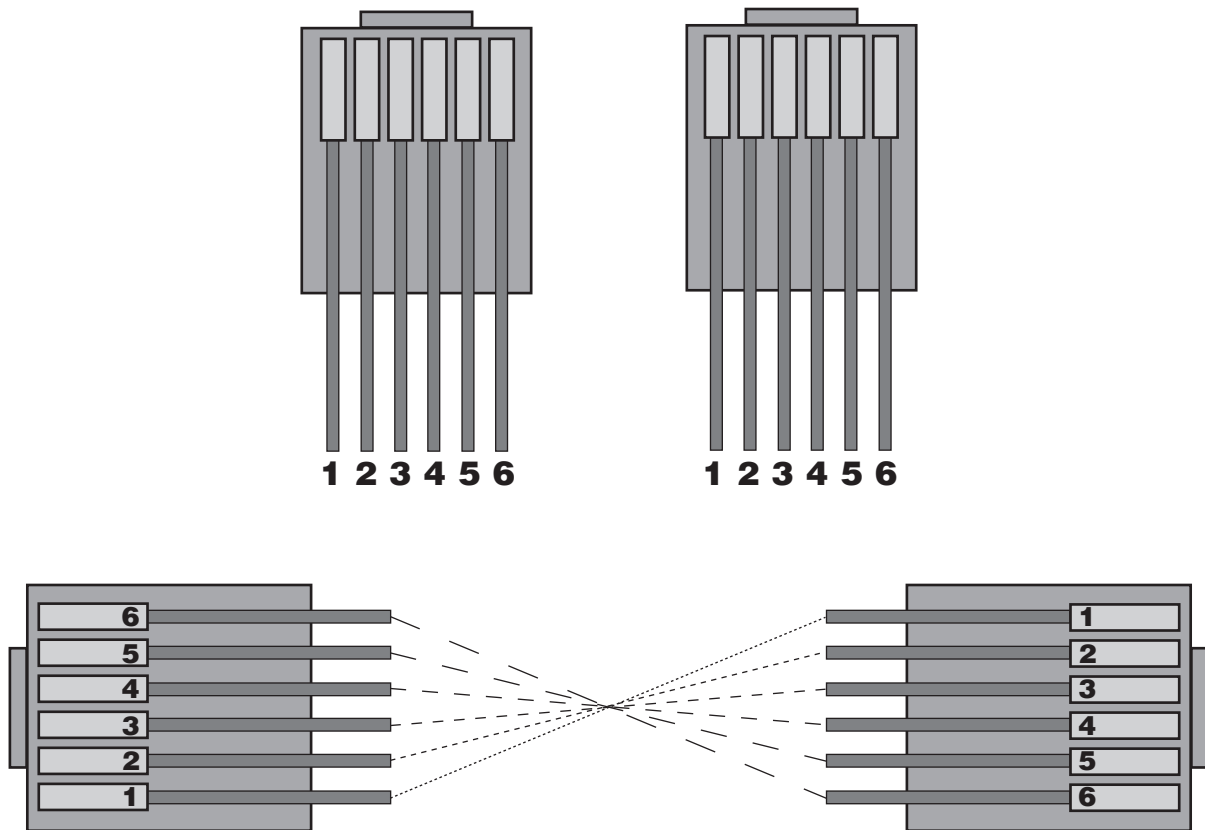

Pic.2.2b

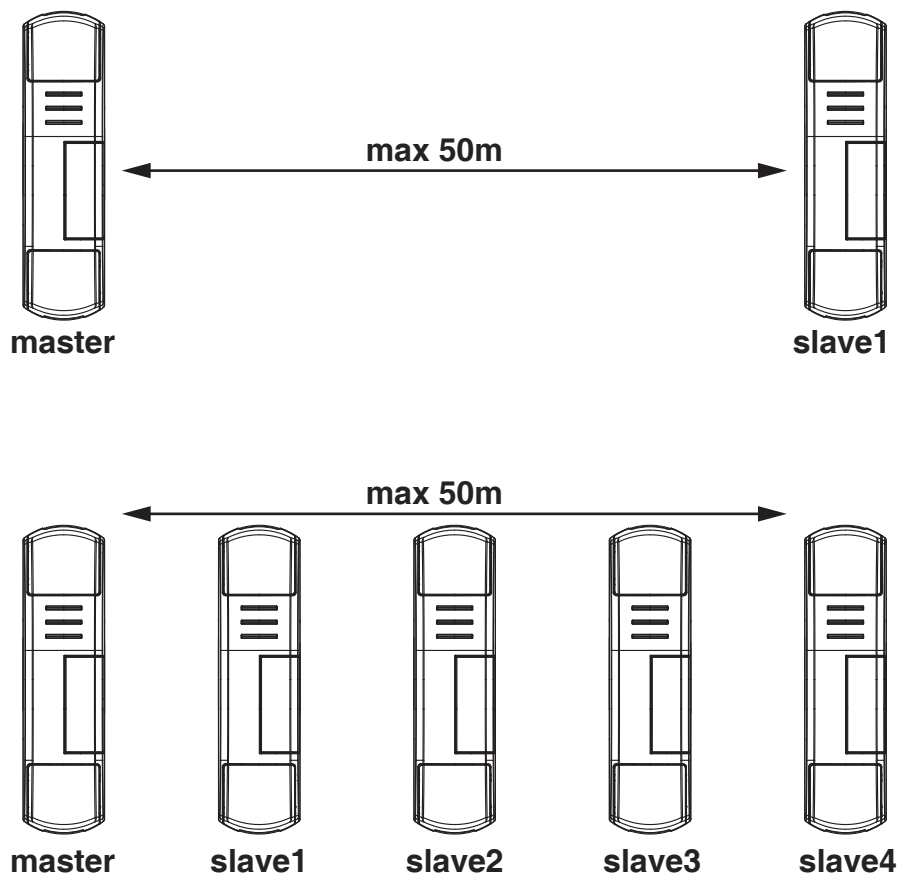

2.3 SET THE OUTPUT CURRENT

With the jumper is possible to set the current provided to the Leds.
The selection is different for each out

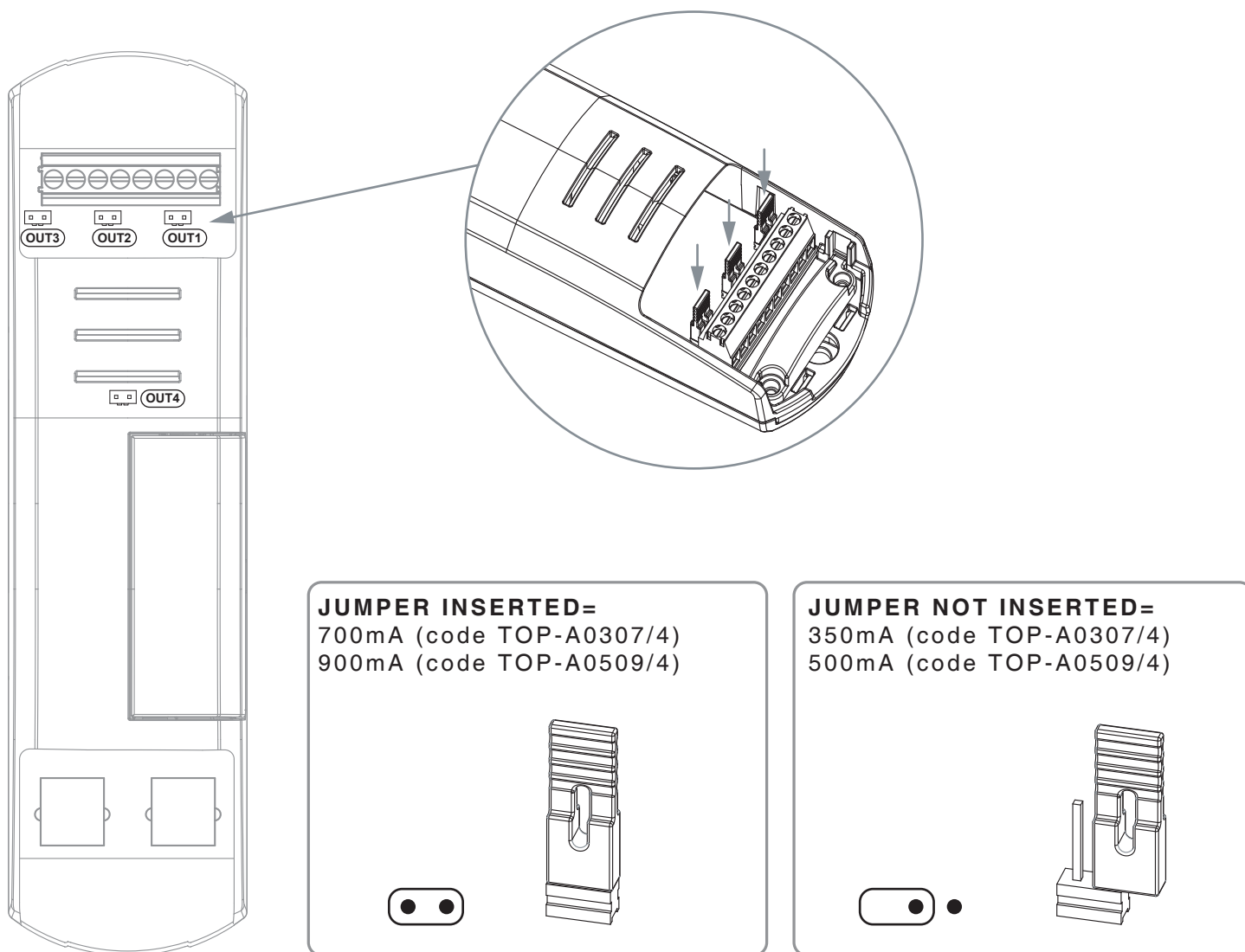

3 USE OF THE CONTROL UNIT

The controller does not provide for commands by wire or by radio.

Actually, its function is to exactly replicate the actions of the master control unit.

Any commands by wire or transmitters will therefore have to interface with the master control unit.



MNLTOP-A/EXT4ENV1.0

Nexta Tech

company brand of Team srl
via G.Oberdan 90, 33074
Fontanafredda (PN) - Italy
Ph. +39 0434 998682
Email: info@nexta-tech.com
Web: www.nexta-tech.com