

# MCX-M/ONE

NEXTA  
T E C H

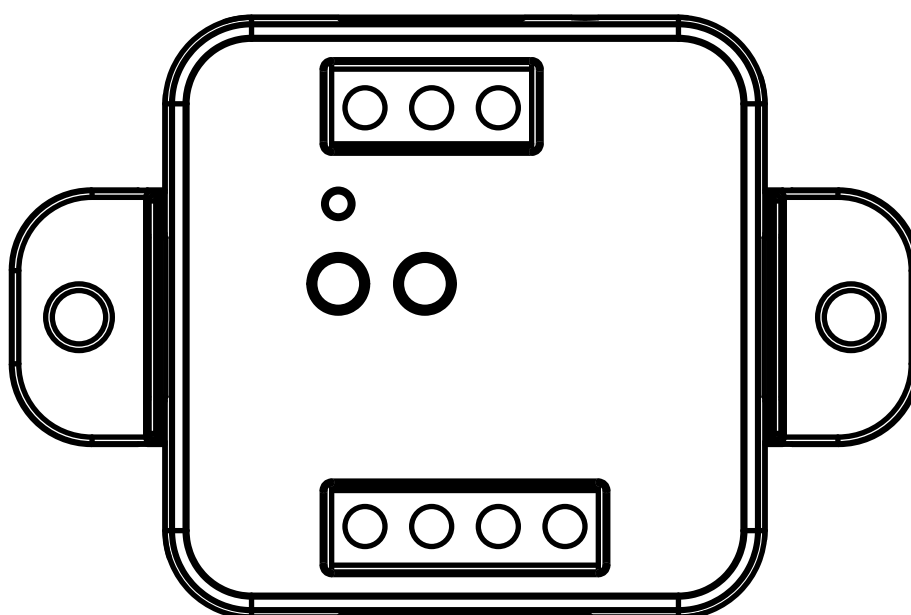

**Control unit for 230Vac motors with built-in dip switches.  
Power supply 230Vac, Max 500W.  
Integrated 433,92 MHz radio receiver.  
WiFi connection for OneSmart App.**

# INDEX

|  |         |
|--|---------|
| 1 - PRODUCT FEATURES   |         |
| 1.1 - TECHNICAL DATA   | page 3  |
| <hr/>  |         |
| 2 - CONNECTION DIAGRAMS  |         |
| 2.1 - CONNECTION DIAGRAM WITH NEUTRAL FROM CONTROL UNIT                | page 4  |
| 2.2 - CONNECTION DIAGRAM WITH NEUTRAL FROM THE ELECTRICAL SYSTEM       | page 5  |
| <hr/>  |         |
| 3 - USE OF THE CONTROL UNIT  |         |
| 3.1 - TYPICAL INSTALLATION   | page 6  |
| 3.2 - USE VIA WIRE   | page 7  |
| 3.3 - USE VIA RADIO  | page 7  |
| 3.4 - USE WITH SMARTPHONE APPLICATION                                  | page 7  |
| 3.5 - USE WITH VOICE CONTROL   | page 7  |
| <hr/>  |         |
| 4 - CONTROL BY RADIOTRANSMITTERS                                       |         |
| 4.1 - RADIOTRANSMITTER SETTING   | page 8  |
| 4.2 - DELETION OF RADIOTRANSMITTERS                                    | page 9  |
| <hr/>  |         |
| 5 - CONTROL WITH APP ONE SMART   |         |
| 5.1 - APP ONE SMART CONNECTION   | page 10 |
| 5.2 - USE OF THE APP ONE SMART   | page 11 |
| <hr/>  |         |
| 6 - CONTROL BY VOICE COMMANDS  |         |
| 6.1 - CONNECTION TO THE APP "GOOGLE HOME"                              | page 12 |
| 6.2 - CONNECTION TO THE APP "AMAZON ALEXA"                             | page 14 |
| <hr/>  |         |
| 7 - ADVANCED PROGRAMS  |         |
| 7.1 - CONFIGURATION OF MANOEUVRE TIMES                                 | page 16 |
| 7.2 - FUNCTION CUSTOMIZATION OF THE "WIRELESS BUS" TRANSMITTER BUTTONS | page 17 |
| 7.3 - WIRED INPUT SETTING  | page 18 |
| 7.5 - WIRED INPUT MODE SETTING   | page 19 |
| 7.4 - RESET  | page 20 |
| <hr/>  |         |

# 1 - PRODUCT FEATURES

## 1.1 TECHNICAL DATA

|                                 |   |
|---------------------------------|---|
| Power supply (Input)            | 230Vac                                    |
| Load type (Output)              | 230Vac motor with built-in limit switches |
| Max power load (Output)         | 500W                                      |
| N° of programmable transmitters | 30  |
| RF receiver frequency           | 433,920MHz                                |
| WI-FI module frequency          | 2,4GHz (no 5GHz)                          |
| Protection rating               | IP20                                      |
| Working temperature             | -20° +55°                                 |
| Box dimensions                  | 52x43x21 mm                               |

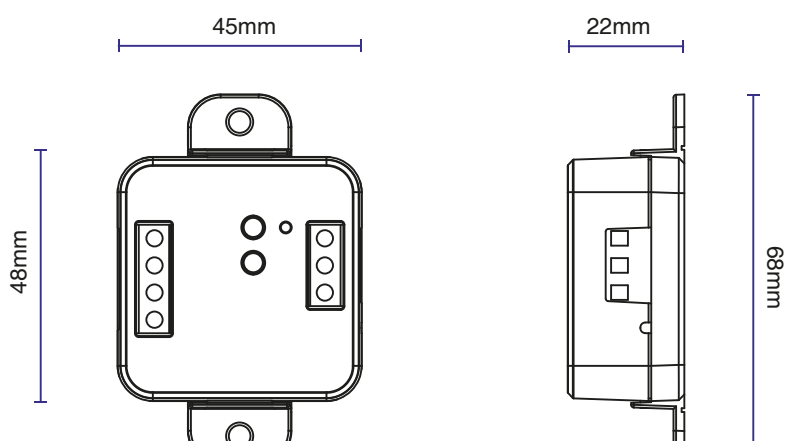
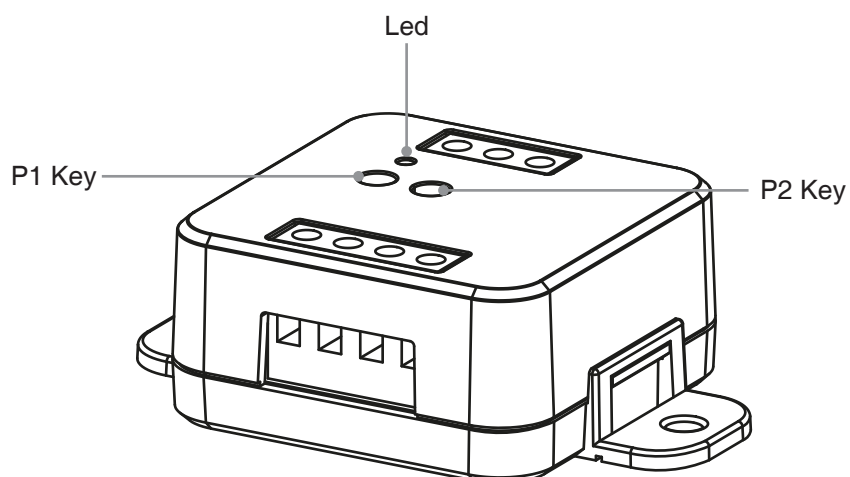

## 2 - CONNECTION DIAGRAMS

### RECOMMENDATIONS

- Installation must be carried out only by professional technicians in accordance with the applicable electrical and safety regulations.
- All connections shall be operated without electrical voltage.
- Use proper cables.
- Don't cut the antenna
- Provide in the power line with an appropriate disconnection device
- Dispose of waste materials in full compliance with local law.
- Do not exceed the specified load limits

### 2.1 CONNECTION DIAGRAM WITH NEUTRAL FROM CONTROL UNIT

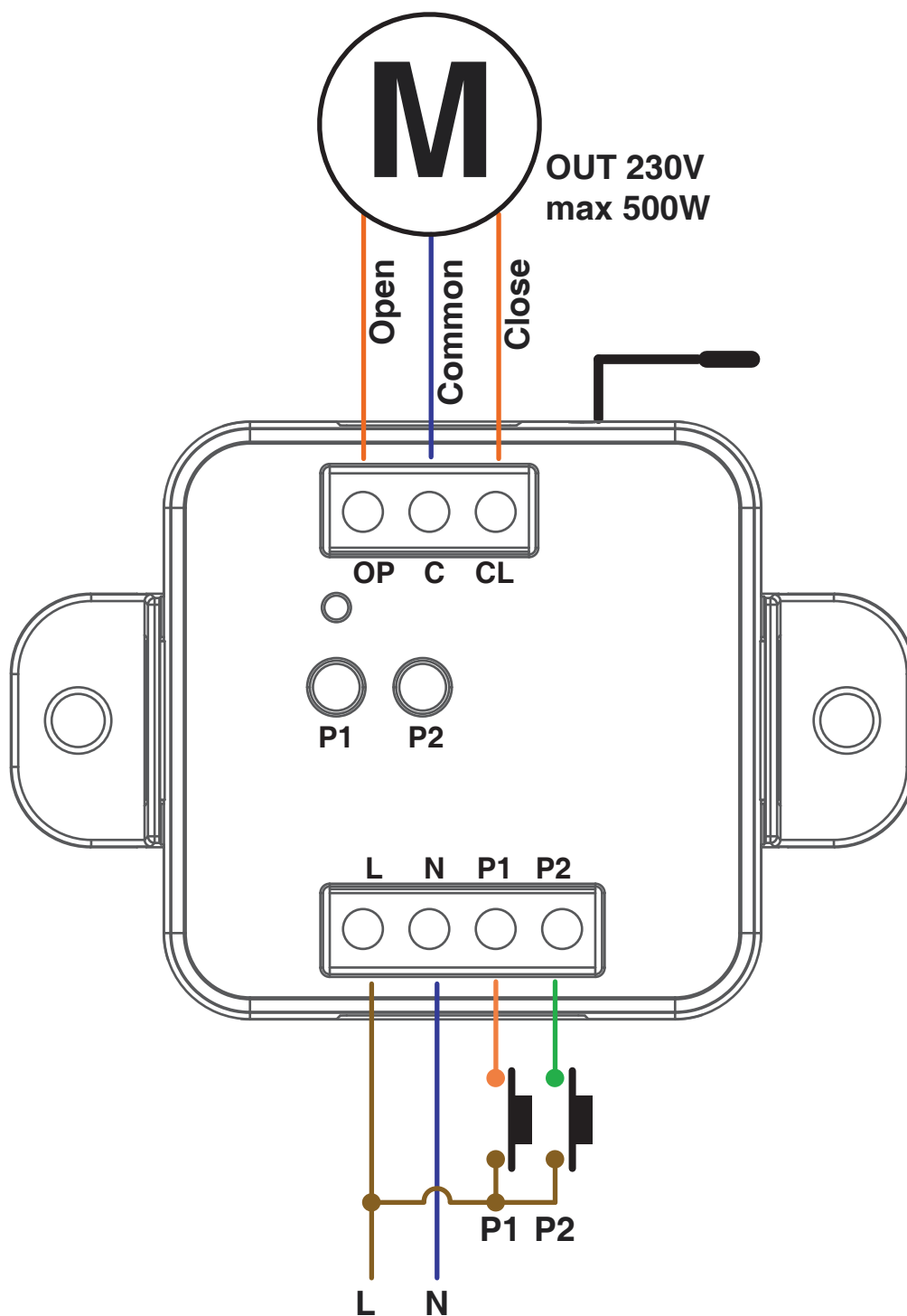

Filar inputs can be set to:

- Mono/Bi Button, see paragraph 7.3
- Automatic/man-present operation, see paragraph 7.4

## 2.2 CONNECTION DIAGRAM WITH NEUTRAL FROM THE ELECTRICAL SYSTEM

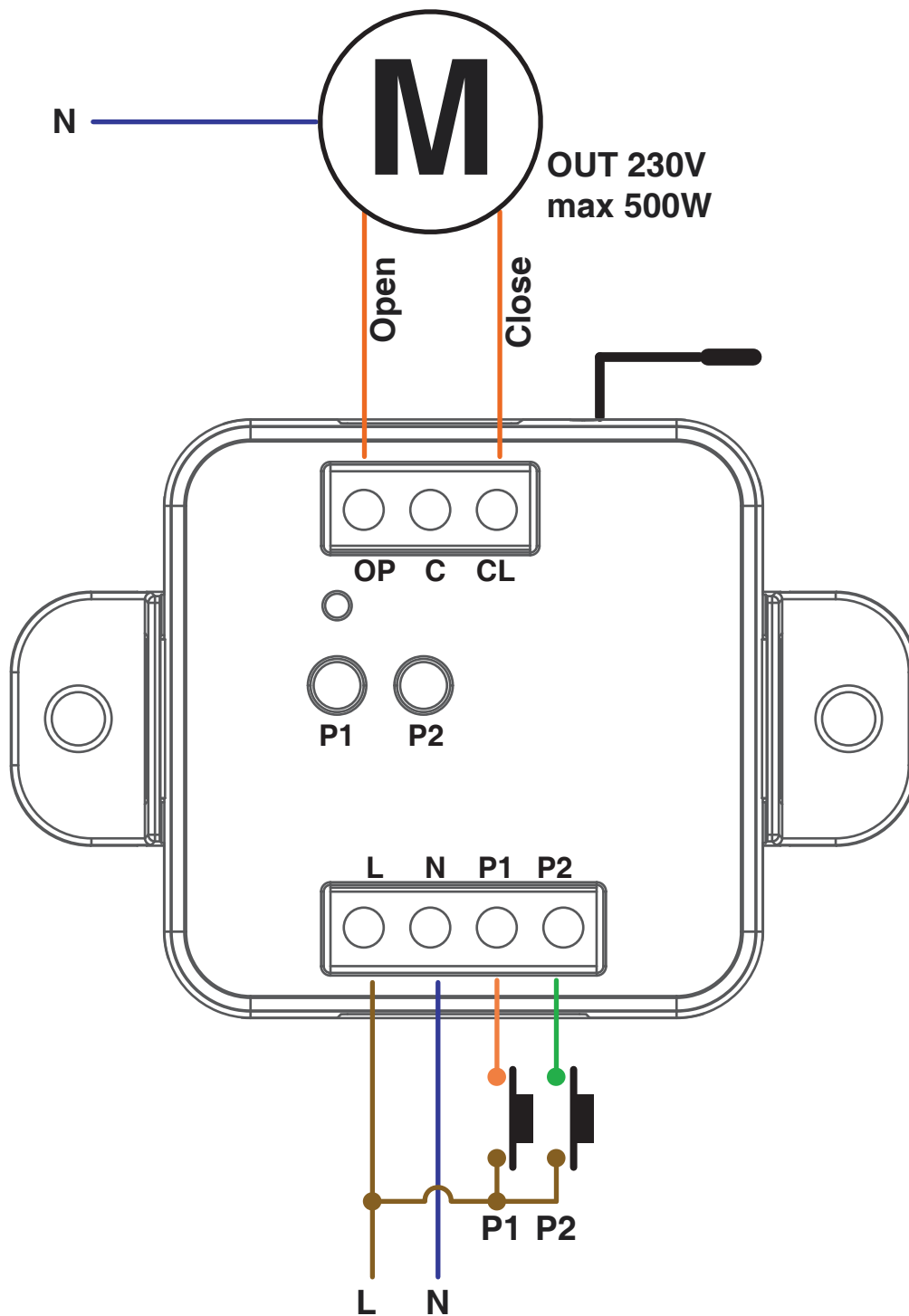

Filar inputs can be set to:

- Mono/Double Button, see paragraph 7.3
- Automatic/man-present operation, see paragraph 7.4

### 3 - USE OF THE CONTROL UNIT

#### 3.1 TYPICAL INSTALLATION

The system can be controlled by a wired push button, radio commands, smartphone App OneSmart or voice commands. The installation can operate with only radio controls or application only. Instead, to use voice commands, at least the App configuration must be completed.

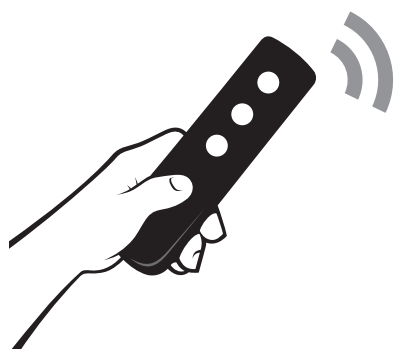

#### RADIOTRANSMITTER CONFIGURATION

See paragraph 4

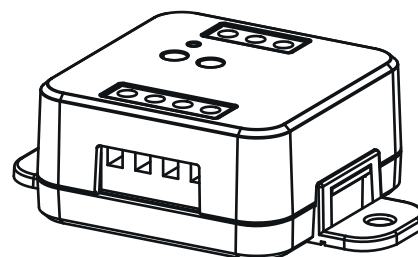

NEXTA CONTROL UNIT

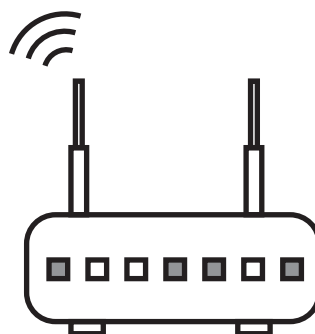

ROUTER WITH INTERNET  
CONNECTION



#### APP CONTROL CONFIGURATION

See paragraph 5



#### VOICE CONTROL CONFIGURATION

See paragraph 6

### **3.2 USE VIA WIRE**

Once connected, the button is already active with Open/Stop/Close function.

### **3.3 USE VIA RADIO**

To control the load via radio you must have compatible transmitters and therefore must carry out the association procedure, see paragraph 4.

### **3.4 USE VIA SMARTPHONE APP ONESMART**

The configuration procedures described in paragraph 5 above must be followed to control the load by smartphone App.

### **3.5 USE WITH VOICE CONTROL**

The configuration procedures described in paragraph 6 above must be followed to control the load by voice commands.

## 4 - MANAGEMENT WITH REMOTE CONTROL

This procedure lets you programme/delete compatible transmitters.

### 4.1 - RADIO PROGRAMMING

This procedure lets you programme compatible multifunctional or generic transmitters.

#### STEP 1

Press the button P1 on the receiver for a short time.  
The LED comes red on and stays on.

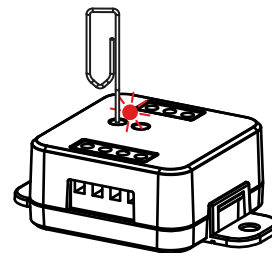

**ACTION:** Short pressure P1 button    **LED:** Turns on red

#### STEP 2

Within 60 seconds make a transmission with the transmitter to be saved.

The LED on the receiver Flashes 3 times and turns off.

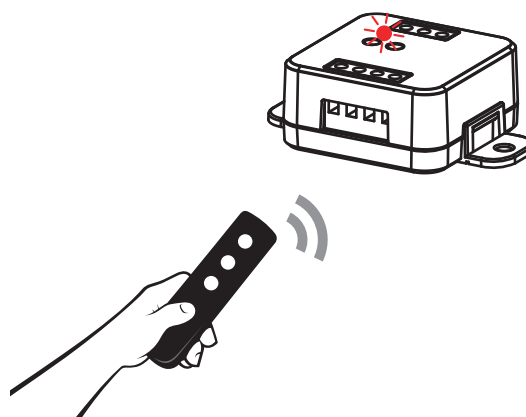

**ACTION:** Send a command with remote control    **LED:** Flashes 3 times



## 4.2 - DELETION OF REMOTE CONTROL

These procedures let you delete from the memory transmitters that have already been programmed.

### STEP 1

Hold the receiver button P1 down (about 8 seconds.) until the LED begins to Flash.

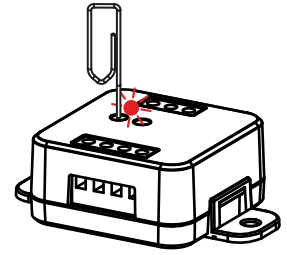

**ACTION:** Hold button P1 down    **LED:** Flashes red

**DELETION OF SINGLE  
TRANSMITTER**

**DELETION OF ALL  
TRANSMITTER SAVED**

### STEP 2a

Within 10 seconds make a transmission with the transmitter that you want to delete.  
The LED flashes quickly and turns off.

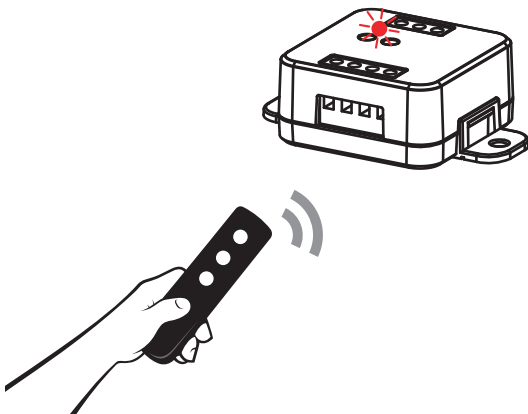

**ACTION:** Make a transmission with the transmitter  
**LED:** Flashing quickly and turns off

### STEP 2B

Within 10 seconds press the button P1 on the receiver for a short time to confirm the deletion of all transmitters.  
The LED starts Flashing quickly and turns off.

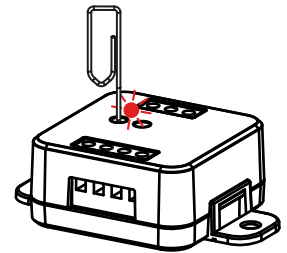

**ACTION:** Short press of button P1  
**LED:** Flashing quickly and turns off

## 5 - CONTROL WITH APP ONE SMART

These procedures allow you to manage the light from your device (example: mobile phone) through the application and to control the system remotely.

### 5.1 - APP CONNECTION

This procedure connects the control unit to the application. It shall be repeated for each control unit on the installation. **ATTENTION:** an internet-based 2,4GHz Wi-Fi (no 5GHz) network is required for this operation.

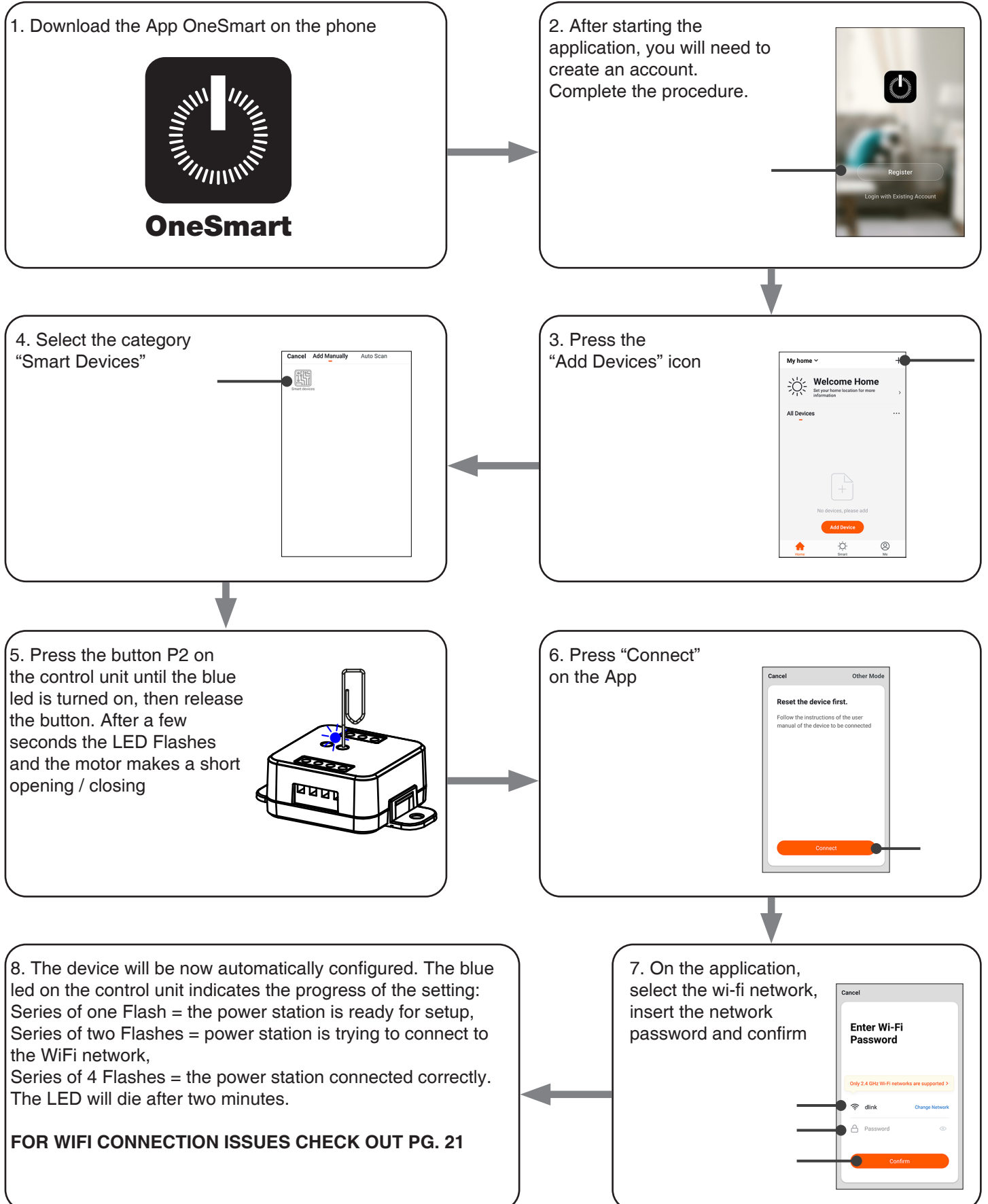

## 5.2 - USE OF THE APP ONE SMART

After all the control units have been set up, the installation can be managed by the application.

### USE

The “Home” menu (1) shows all the associated devices.  
To send a command to a device, select it.

Pressing “Smart” (2) allows you to add actions on your devices according to certain conditions and in certain time intervals, there are two types of actions:

- Automation (3): One or more actions happen if one or more conditions are satisfied
- Tap-to-Run (Scenario) (4): performs one or more actions by pressing an app button

#### EXAMPLES OF SCENARIOS (TAP-TO-RUN):

- Total open of the rolling shutters
- Scenario Film (Close the rolling shutter and dimming the desired lights at low intensity level)

#### EXAMPLES OF AUTOMATIONS:

- Hourly and weekly programs
- Close the rolling shutters at the sunshine
- 

Pressing “Me” (5) for entering to home and account settings.

From this menu, you can add members to the home for sharing device management or creating new houses.

#### PROCEDURE FOR ADDING NEW USERS/MEMBERS.

1- From the “ME” menu (5), select “Home Management” (7) and then go to the house configurations and find “Add Member”

2- Insert the “OneSmart” account you want to add (email or mobile phone number of the new member), the new member will receive a notification of the invitation.

#### WARNING:

- The new user must have already downloaded the “OneSmart” application and created an account.
- Both the ‘administrator’ and the ‘new user’ must have set the same ‘region’ (Country).
- (Go to “Account (2)-Account and Security-Region” to view and change the set country).

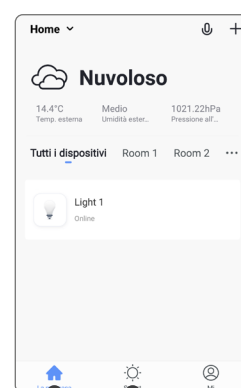

Home (1) Smart (2)

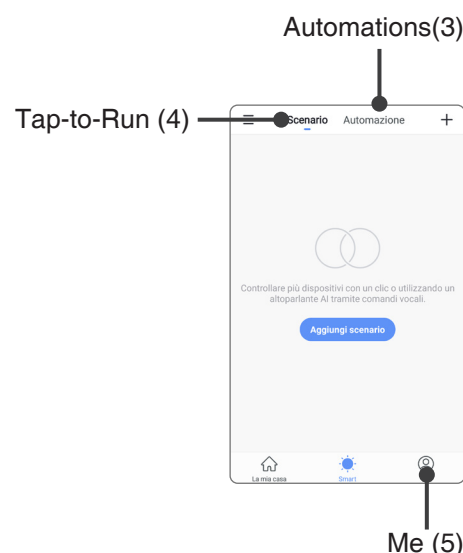

Automations(3)  
Tap-to-Run (4)  
Me (5)

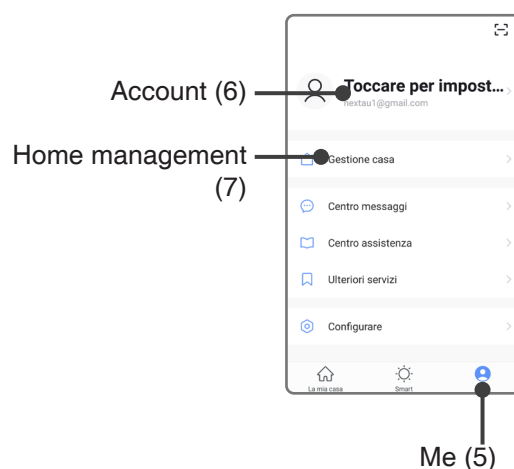

Account (6)  
Home management (7)  
Me (5)

## 6 - CONTROL BY VOICE COMMANDS

You can use this procedure to associate a “OneSmart” account with a Google or Alexa account to enable the voice commands.

### 6.1 - CONNECTION TO “GOOGLE HOME”

#### PROCEDURE

**WARNING:** before proceeding with this procedure, you must have set up the “OneSmart” account, see paragraph 6.

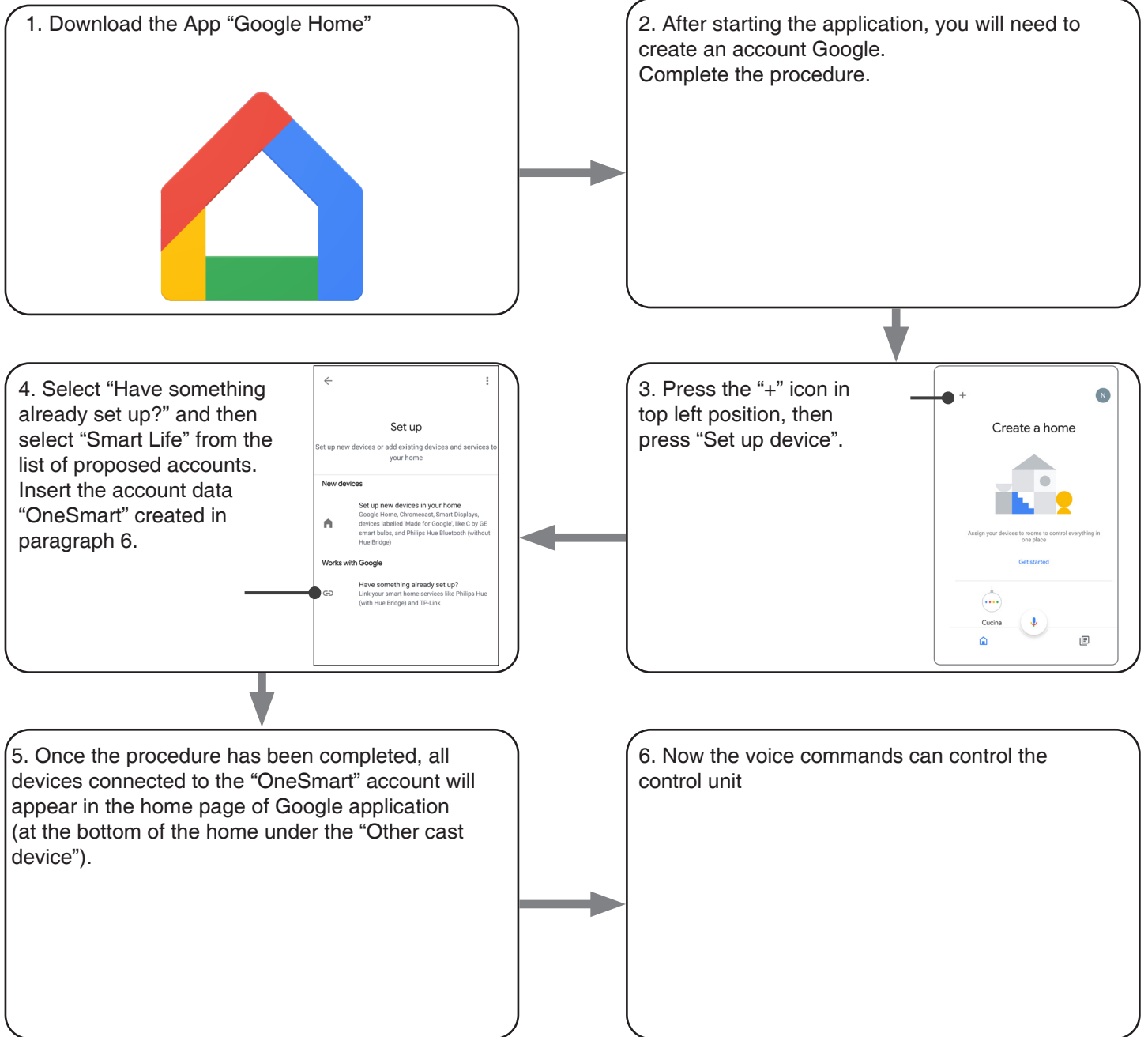

#### NOTES:

If you add other devices to your OneSmart application, they will automatically be added to the Google Home page. To use them with voice control, you need to add them to a room in the Google Home application, see step 6 of the procedure.

If devices are not added automatically, disconnect and reconnect your account from step 3 of this procedure from Google Home.

## 6.2 - CONNECTION TO “AMAZON ALEXA”

### PROCEDURE

WARNING: before proceeding with this procedure, you must have set up the “OneSmart” account, see paragraph 6.

1. Download the App “Amazon Alexa”



2. After starting the application, you will need to create an account Amazon. Complete the procedure.

3. From the application home page press “menu” (1) then “Skill and games” (2). Press on the “Magnifying glass” at the top right and then search for “Smart Life” (3). Follow the procedure to enable use of the “OneSmart” account created using paragraph 6

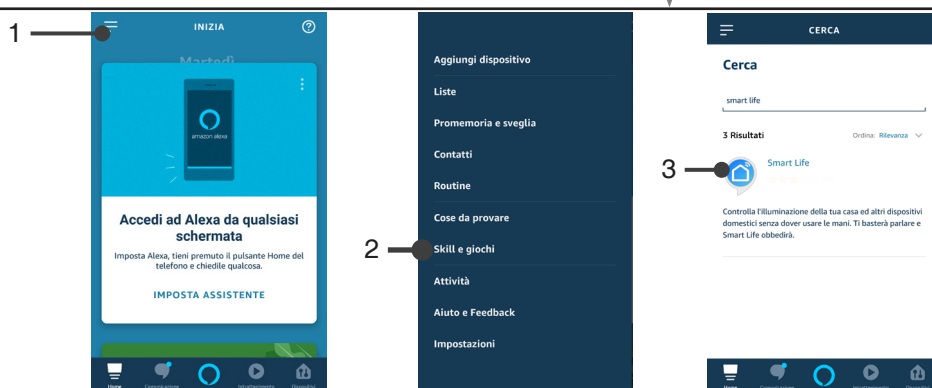

4. Complete the procedure by entering the “OneSmart” account data created in paragraph 6. You can then start searching for devices by pressing the “Discover devices” button (4). If you want, complete the setting-up procedure by inserting the device into a room.

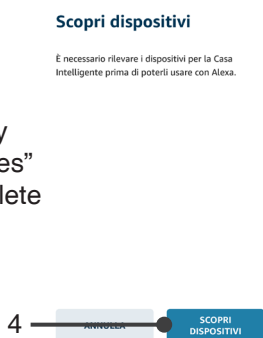

5. Now the voice commands can control the control unit

### 6.3 - USING VOICE CONTROLS

In order to set up voice commands, you must create a scene on OneSmart and then associate it with a Google or Alexa routine by choosing the phrase to pronounce to match the most appropriate action.

You must create a scene for each command you want to use with the voice.

The available commands are: Open / Stop / Close / Partial Open

#### 6.3a - CREATING A SCENARIO ON ONE SMART

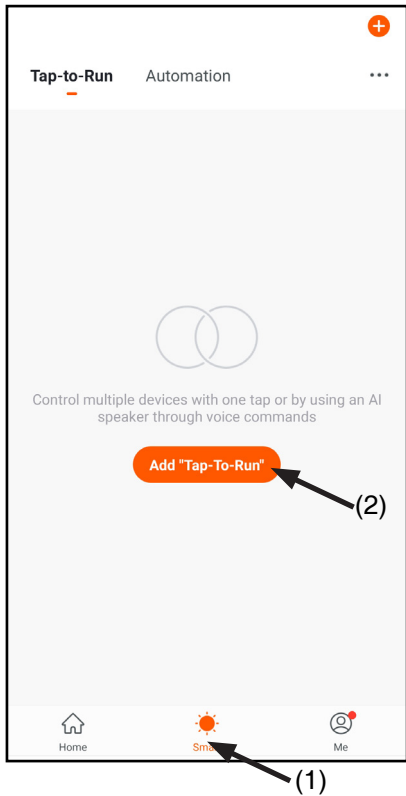

- On the OneSmart application go to the Smart window (1)
- Press "Add Tap to Run" (2)
- As a condition, select "Click to execute" (3)
- Select the device, then select the the desired command (open, stop, close or partial open) (4)
- Rename and save

#### 6.3b - CREATING A GOOGLE ROUTINE

1 - On the Google Home application, select Routines (1)

2 - Create a new routine and insert the phrase you want to pronounce to "Add Commands" (2)

3 - On "+ Add Action" (3), select "Browse popular actions" (4) and then "Adjust Scenes" (5)

4 - Select the scene created on OneSmart in procedure 6.3a.

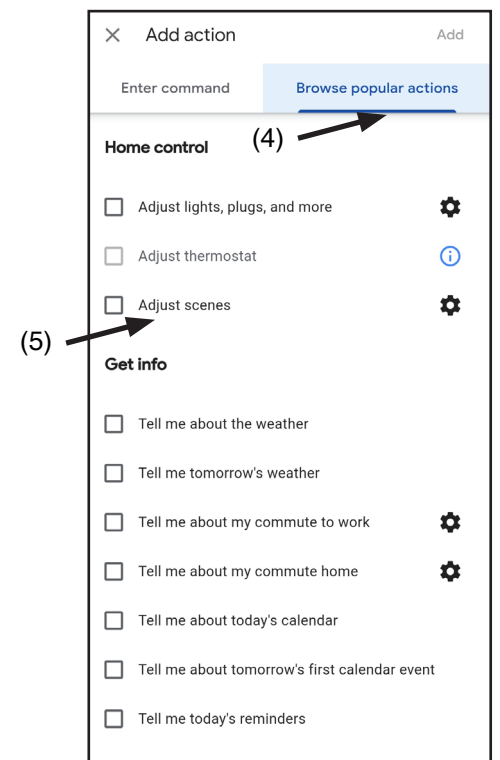
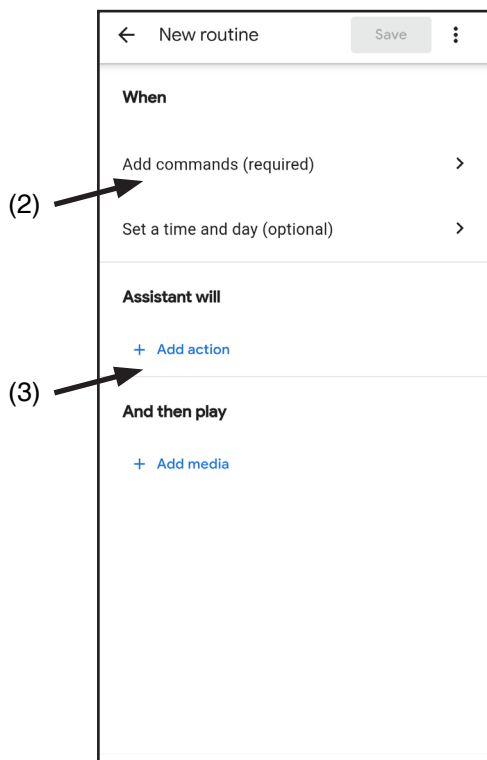
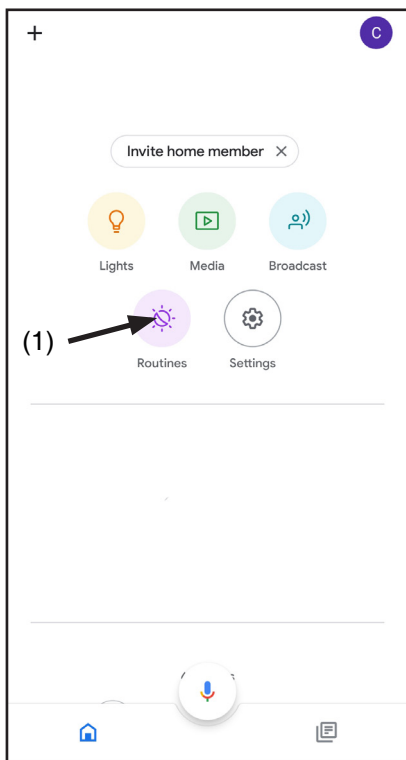

### 6.3c - CREATING A ALEXA ROUTINE

1 - On Alexa application, select the menu (1)

2 - Select "Routines" (2), and then add a new one

3 - Enter the name (3), the phrase you want to pronounce (4), and "add an action" (5) select "Smart Home", then select "Control scene". Select the scene created on One Smart in procedure 6.3a.

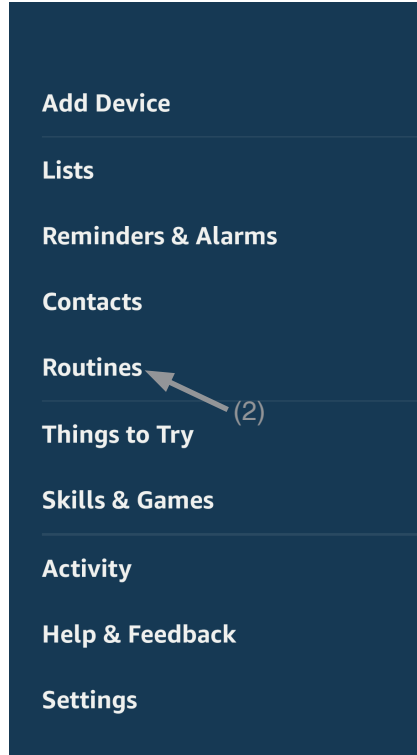
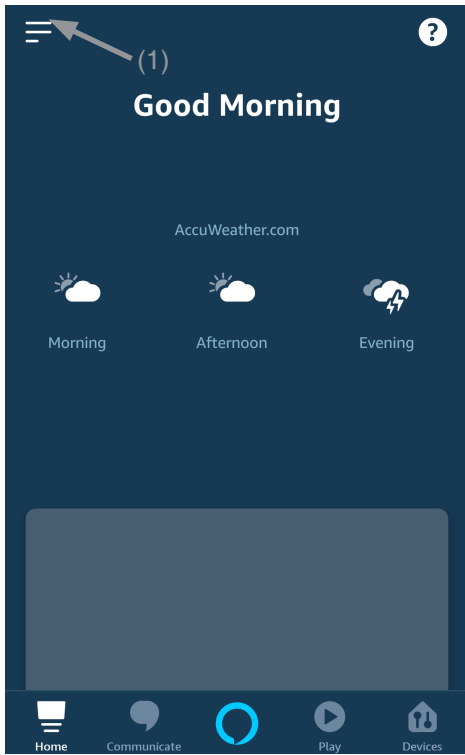

## 7 - ADVANCED PROGRAMS

### 7.1 - CONFIGURATION OF MANEUVER TIMES

Default: 60 seconds

This procedure is used to set the opening and closing manoeuvre time (maximum time that can be set 180 seconds).

#### STEP 1

Make short pressures of the P2 button.  
Each time the LED changes colour green/yellow/magenta/  
green...  
Stop pressing when the LED is green.

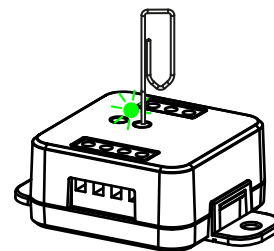

**ACTION:** make a short presses of button P2 **LED:** Turns on green/yellow/magenta/green...

#### STEP 2

Press the button P1 on the receiver for a short time and count the  
number of Flashes emitted by the LED (max 180 Flashes): each  
Flash represents a second of manoeuvre time.

Attention: the control unit Flashes one time every 1 second, example:  
120 seconds = 120 Flashes = 2 minutes of manoeuvre

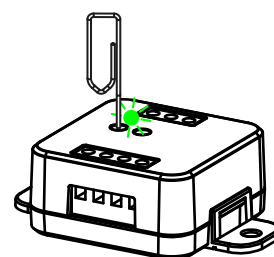

**ACTION:** Short pressure P1 button **LED:** Flash

#### STEP 3

To end the count press the button P1 for a short time during the  
Flash that corresponds to the function desired

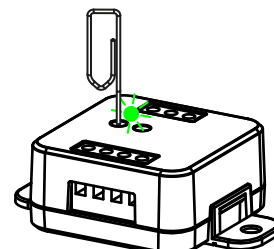

**ACTION:** Short pressure P1 button **LED:** Turns off



## 7.2 - FUNCTION CUSTOMIZATION OF THE “WIRELESS BUS” GENERIC TRANSMITTER BUTTONS

The following procedure allows you to set a custom function to the “wireless bus” family transmitter button.

### PROCEDURE

#### STEP 1

Press the button P1.  
The led turns on red.

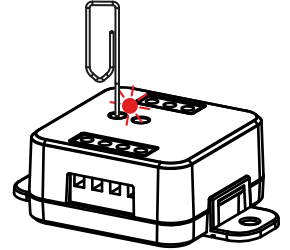

**ACTION:** Short press of button P1    **LED:** Turns on red

#### STEP 2

Press the button P2 on the receiver for a short time and count the number of Flashes emitted by the LED:

| NUMBER OF FLASHES | FUNCTION                               |
|-------------------|--|
| 1                 | Open                                   |
| 2                 | Stop                                   |
| 3                 | Close                                  |
| 4                 | Open (short press) /Stop (long press)  |
| 5                 | Close (short press) /Stop (long press) |

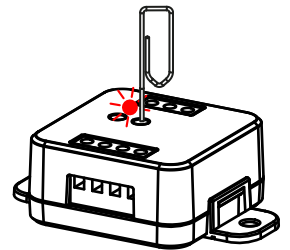

**ACTION:** Short press of button P2    **LED:** Count the number of Flashes

#### STEP 3

Press the button P2 for a short time during the Flash that corresponds to the function desired to end the count.  
The led stop Flashes and lights up steadily.

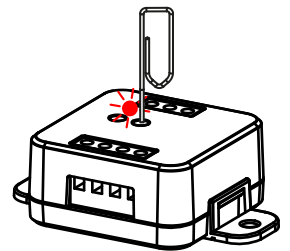

**ACTION:** Short pressure of button P2 during the Flash    **LED:** Stop Flashes

#### STEP 4

Make a transmission with the transmitter to be saved  
(see transmitter manual, paragraph entitled “transmitter programming”).  
The LED on the receiver Flashes 3 times and turns off.

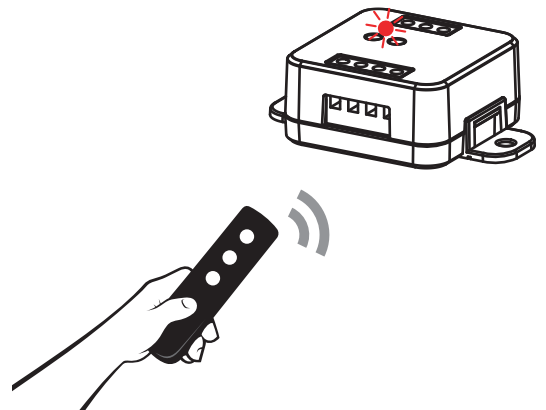

**ACTION:** Make a transmission with the transmitter    **LED:** Flashes 3 times

### 7.3 - WIRED INPUT SETTING

Default: Mono button

This procedure lets you select the function of inputs "P1" (terminal 3) and "P2" (terminal 4). **WARNING:** the connected devices must be buttons.

#### PROCEDURE

##### STEP 1

Make short pressures of the P2 button.  
Each time the LED changes color: green/yellow/magenta/green...  
Release the key when the led is yellow

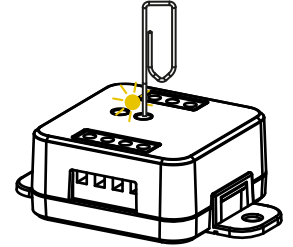

**ACTION:** Short presses of buttons P2 **LED:** green/yellow/magenta/green...

##### STEP 2

Press the button P1 on the receiver for a short time and count the number of Flashes emitted by the LED:

| NUMBER OF FLASHES | FUNCTION   |
|-------------------|--|
| 3                 | Mono Button:<br>P1= Open/Stop/Close              |
| 6                 | Double button<br>P1= Open/Stop<br>P2= Close/Stop |

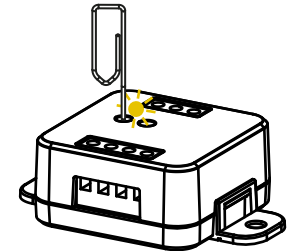

**ACTION:** Short pressure P1 button **LED:** Flash

##### STEP 3

To change the setting, repeat the procedure from point 1; the control unit will alternate between 3 and 6 Flashes.

## 7.4 - WIRED INPUT MODE SETTING

Default: automatic

This procedure allows you to select the mode of operation between:

automatic: after pressing the button the automation completes the movement to the limit switch

present man: automation moves until the button is pressed

### PROCEDURE

#### STEP 1

Make short pressures of the P2 button.

Each time the LED changes colour green/yellow/magenta/green...

Release the key when the led is magenta

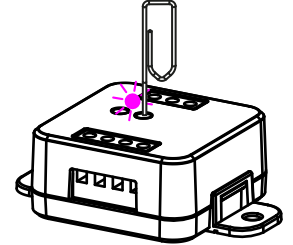

**ACTION:** Short presses of button P2 **LED:** green/yellow/magenta/green...

#### STEP 2

Press the button P1 on the receiver for a short time and count the number of Flashes emitted by the LED:

| NUMBER OF FLASHES | FUNCTION    |
|-------------------|-------------|
| 3                 | Automatic   |
| 6                 | Present man |

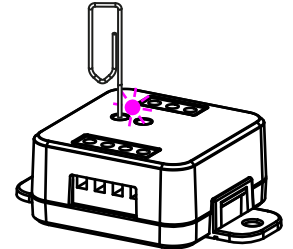

**ACTION:** Short pressure P1 button **LED:** Flash

#### STEP 3

To change the setting, repeat the procedure from point 1; the control unit will alternate between 3 and 6 Flashes.

## 7.5 - RESET OF THE CONTROL UNIT

This procedure let you take the control unit back to factory settings.

ATTENTION: the only parameter that will not be removed will be the association with the ONESMART application.  
To edit or delete also this parameter, reed the procedure.

### PROCEDURE

#### STEP 1

Hold the receiver button P1 down (about 4 seconds.) until the LED begins to Flash red.

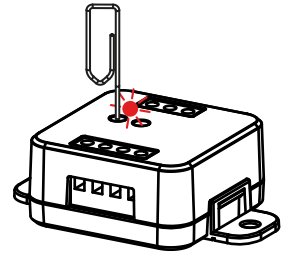

**ACTION:** Hold button P1 down    **LED:** Flashes red



#### STEP 2

Within 10 seconds, make a short press of P2 button.  
The LED 1 Flashes quickly and turns off.

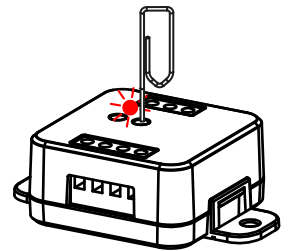

**ACTION:** Short press of P2 button    **LED:** The led Flash quickly and turns off

## 8 - INSIGHTS

### 8.1 – ISSUES WHEN CONNECTING THE CONTROL UNIT WITH WIFI

If you're having problems connecting the control unit to the router, we suggest to:

#### FIRST CHECKS:

- check if the network used to connect the control unit is running at 2.4GHz (not 5GHz)
- the smartphone you use must be connected to the same WiFi on which you want to connect the device
- please check if the entered password is correct

#### STEPS TO DO:

- close the app and try again to connect the device
- if possible try with another smartphone to check if it works

If the problem is not fix, there may be some settings in your router that make the network incompatible with the device. To check and change these settings it's necessary to access the router settings.

As soon as you access the router settings (it depends on the model of router you have) try to check and set these parameters:

#### WIFI FREQUENCY BAND

some routers generate a network that is set automatically at a frequency of 2.4GHz or 5GHz, depending on the device you are connecting with. When you are trying to connect the device through your OneSmart account, your smartphone may be connected automatically at the frequency band of 5GHz, failing the connection with your device.

It's therefore necessary to access the router settings and set the 2.4GHz as the main network frequency to use.

Otherwise it's possible to create two different WiFi networks, one for the 2.4GHz and one for the 5GHz band, and during the pairing phase make sure your smartphone is connected to the 2.4GHz network.

#### WIFI SECURITY SETTINGS

some routers could have default security settings not compatible with the device.

Please find out which security protocol type your Wi-Fi router is and change it to:

#### WI-FI SECURITY:

SECURITY TYPE: WPA2  
ENCRYPTION TYPE: AES







V1.1

**Nexta Tech**  
company brand of Team srl  
via G.Oberdan 90, 33074  
Fontanafredda (PN) - Italy  
Ph. +39 0434 998682  
Email: [info@nexta-tech.com](mailto:info@nexta-tech.com)  
Web: [www.nexta-tech.com](http://www.nexta-tech.com)