

# MCU-DM/ONE

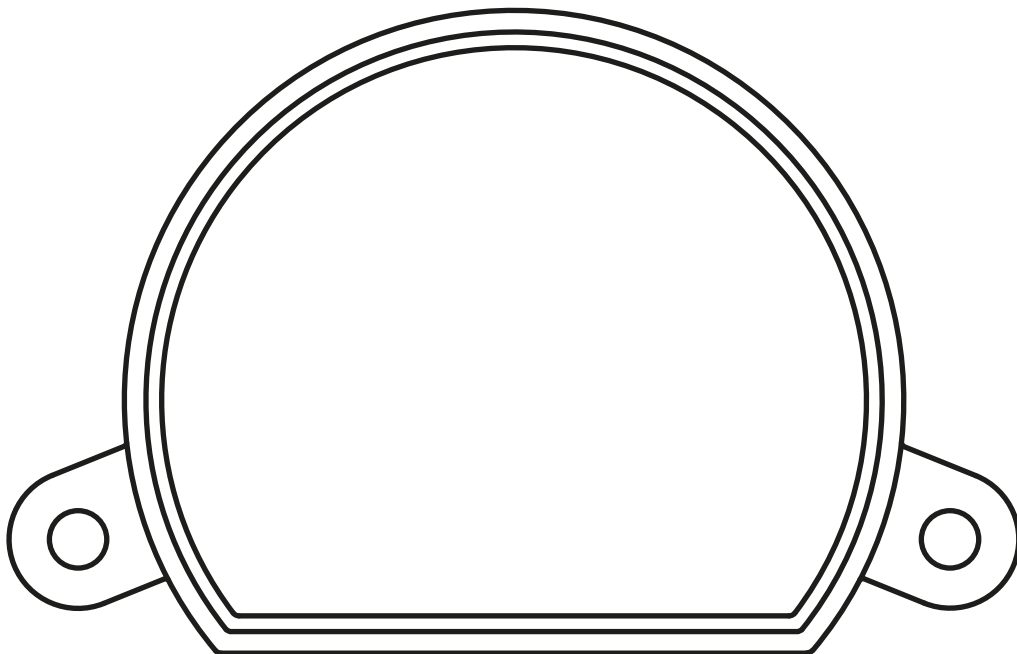

**Control unit for 230Vac loads with phase cut dimmer.  
Power supply 230Vac, Max 150W.  
Integrated 433.92 MHz radio receiver.  
WiFi connection for OneSmart App.**

# INDEX

1 - PRODUCT FEATURES	
1.1 - TECHNICAL DATA	pagina 3
<hr/>	
2 - CONNECTION DIAGRAMS	
2.1 - CONNECTION DIAGRAM WITH NEUTRAL FROM CONTROL UNIT	pagina 4
2.2 - CONNECTION DIAGRAM WITH NEUTRAL FROM THE ELECTRICAL SYSTEM	pagina 5
<hr/>	
3 - USE OF THE CONTROL UNIT	
3.1 - TYPICAL INSTALLATION	pagina 6
3.2 - USE VIA WIRE	pagina 7
3.3 - USE VIA RADIO	pagina 7
3.4 - USE WITH SMARTPHONE APPLICATION	pagina 7
3.5 - USE WITH VOICE CONTROL	pagina 7
<hr/>	
4 - CONTROL BY RADIOTRANSMITTERS	
4.1 - RADIOTRANSMITTER SETTING	pagina 8
4.2 - DELETION OF RADIOTRANSMITTERS	pagina 9
<hr/>	
5 - CONTROL WITH APP ONE SMART	
5.1 - CONNESSIONE ALL'APPLICAZIONE "ONESMART"	pagina 10
5.2 - USE OF THE APP ONE SMART	pagina 11
<hr/>	
6 - CONTROL BY VOICE COMMANDS	
6.1 - CONNECTION TO THE APP "GOOGLE HOME"	pagina 12
6.2 - CONNECTION TO THE APP "AMAZON ALEXA"	pagina 14
<hr/>	
7 - ADVANCED PROGRAMS	
7.1 - SETTING ADJUSTABLE MINIMUM BRIGHTNESS	pagina 16
7.2 - FUNCTION CUSTOMIZATION OF THE GENERIC TRANSMITTER BUTTONS	pagina 17
7.3 - SETTING TIMING	pagina 18
7.4 - SETTING ADJUSTABLE MINIMUM BRIGHTNESS	pagina 19
7.5 - RESET	pagina 20
<hr/>	

# 1 - PRODUCT FEATURES

## 1.1 TECHNICAL DATA

Power supply (Input)	230Vac
Load type (Output)	230Vac load
Max power load (Output)	150W
N° of programmable transmitters	30
RF receiver frequency	433.920MHz
Frequenza modulo WI-FI	2.4GHz
Protection rating	IP20
Working temperature	-20° +55°
Box dimensions	52x43x21 mm

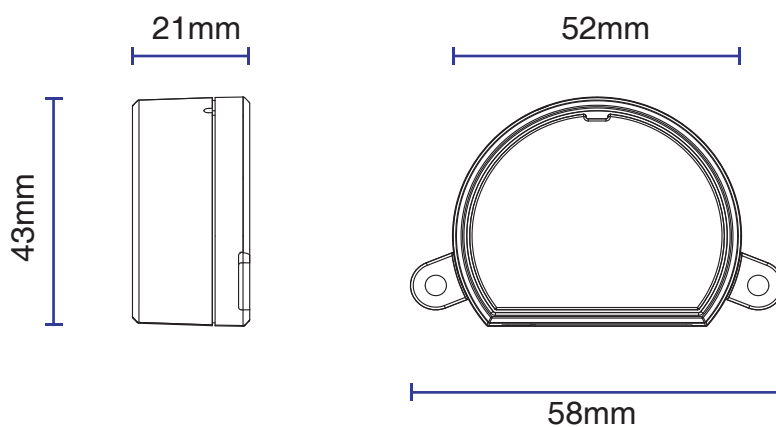
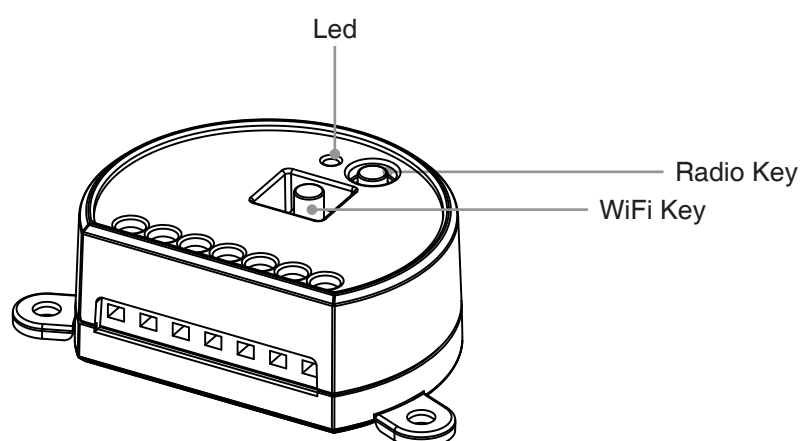

## 2 - CONNECTION DIAGRAMS

### RECOMMENDATIONS

- Installation must be carried out only by professional technicians in accordance with the applicable electrical and safety regulations.
- All connections shall be operated without electrical voltage.
- Use proper cables.
- Don't cut the antenna
- Provide in the power line with an appropriate disconnection device
- Dispose of waste materials in full compliance with local law.
- Do not exceed the specified load limits and use correctly protected power supplies.

### 2.1 CONNECTION DIAGRAM WITH NEUTRAL FROM CONTROL UNIT

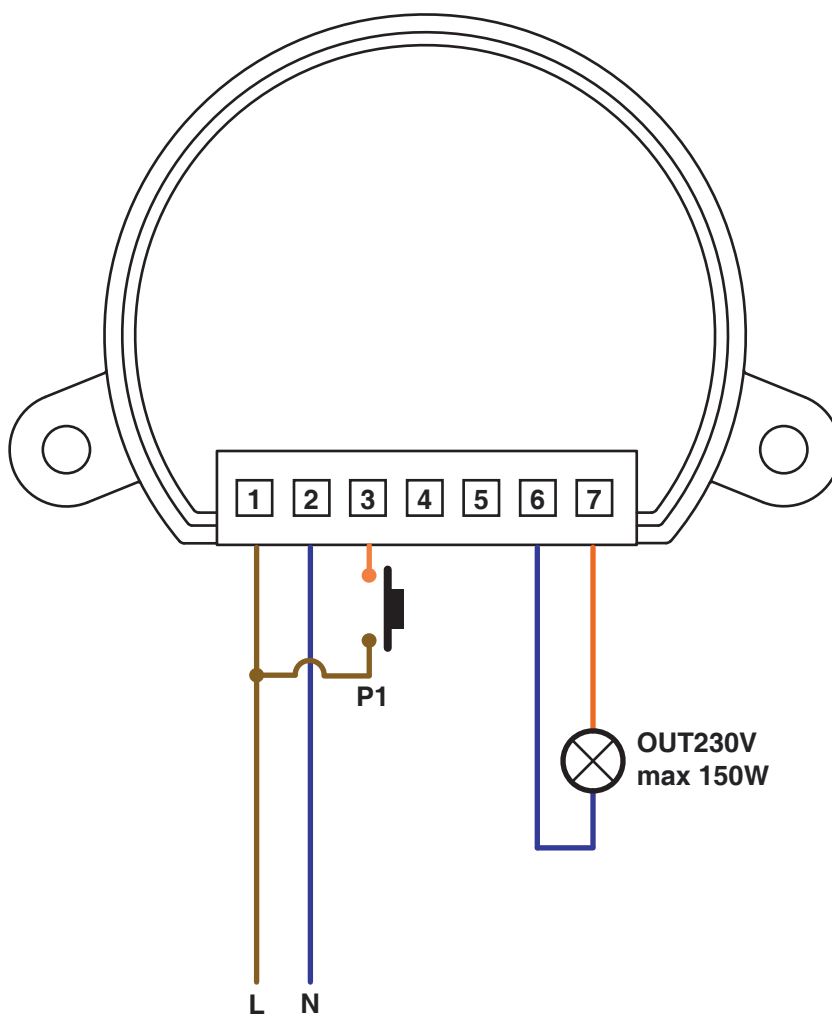

## 2.2 CONNECTION DIAGRAM WITH NEUTRAL FROM THE ELECTRICAL SYSTEM

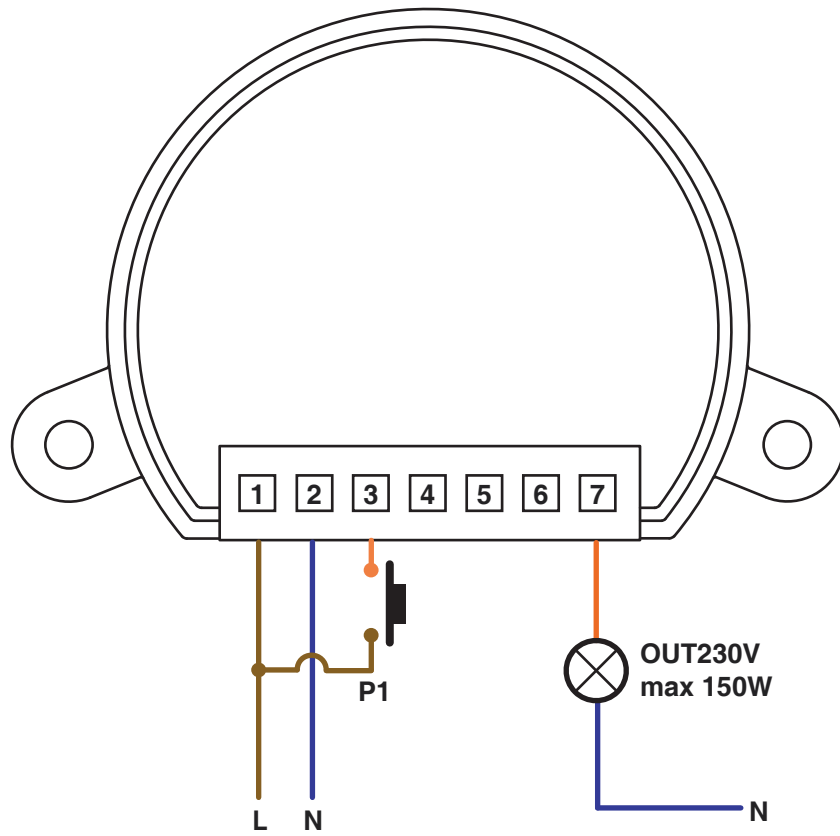

### 3 - USE OF THE CONTROL UNIT

#### 3.1 TYPICAL INSTALLATION

The system can be controlled by a wired push button, radio commands, smartphone App OneSmart or voice commands. The installation can operate with only radio controls or application only. Instead, to use voice commands, at least the App configuration must be completed.

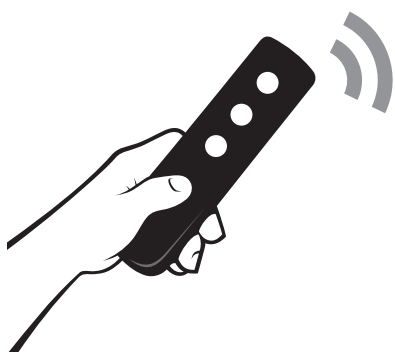

#### RADIOTRANSMITTER CONFIGURATION

See paragraph 4

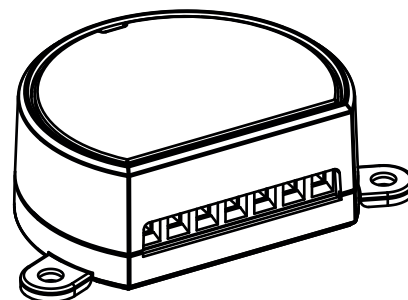

NEXTA CONTROL UNIT

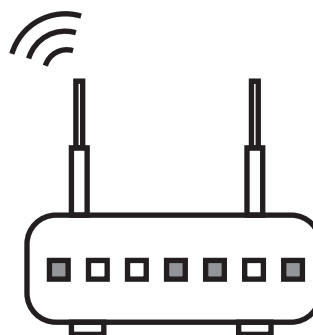

ROUTER WITH INTERNET  
CONNECTION



#### APP CONTROL CONFIGURATION

See paragraph 5



#### VOICE CONTROL CONFIGURATION

See paragraph 6

### **3.2 USE VIA WIRE**

Once connected, the button is already active with On/Off and dimmer function.

### **3.3 USE VIA RADIO**

To control the loads via radio you must have compatible transmitters and therefore must carry out the association procedure, see paragraph 4.

### **3.4 USE VIA SMARTPHONE APP ONESMART**

The configuration procedures described in paragraph 5 above must be followed to control the lights by smartphone App.

### **3.5 USE WITH VOICE CONTROL**

The configuration procedures described in paragraph 6 above must be followed to control the lights by voice commands.

## 4 - MANAGEMENT WITH REMOTE CONTROL

This procedure lets you programme/delete compatible transmitters.

### Multifunctional transmitters, codes:

HB70-SLCT, HB70-SPCT,  
HB80-1C, HB80-1DIM, HB80-2L, HB80-30D, HB80-30RGBW, HB80-4C, HB80-4DIM, HB80-4L,  
HB90-6LT,  
ROUND-1SP,  
SENSA-M, SENSA-P, SENSA-R35M, SENSA-R35P, SENSA-R35T, SENSA-T,  
TOUCH-1, TOUCH-1CCT, TOUCH-1DIM, TOUCH-1SP, TOUCH-1L, TOUCH-1RGBW, TOUCH-3C, TOUCH-4DIM, TOUCH-CFU

With multifunctional transmitters the transmitter control modes depend on the model used.

Refer to the transmitter manual, to the paragraph entitled “commands sent by the transmitter”, bearing in mind that this is an Dimmer device.

### Generic (wireless bus) transmitters, codes:

HB80-6G, MCU-TX4, TOUCH-1G, TOUCH-2G, TOUCH-4G, TOUCH-LOCK4, TOUCH-TX2, ROUND-1G

With generic transmitters, the function of the button is On/Off and dimmer

The function of the generic transmitters can be customized using the procedure in paragraph 7.2.

### 4.1 - RADIO PROGRAMMING

This procedure lets you programme compatible multifunctional or generic transmitters.

#### STEP 1

Press the button radio on the receiver for a short time.  
The LED comes on and stays on.

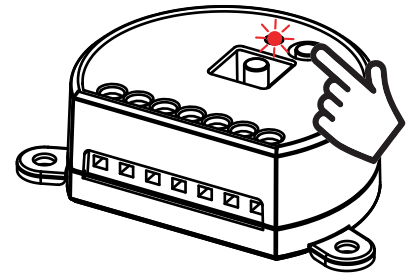

**AZIONE:** Short pressure RADIO button    **LED:** Turns on red

#### STEP 2

Within 60 seconds make a transmission with the transmitter to be saved.

The LED on the receiver Flashes 3 times and turns off.

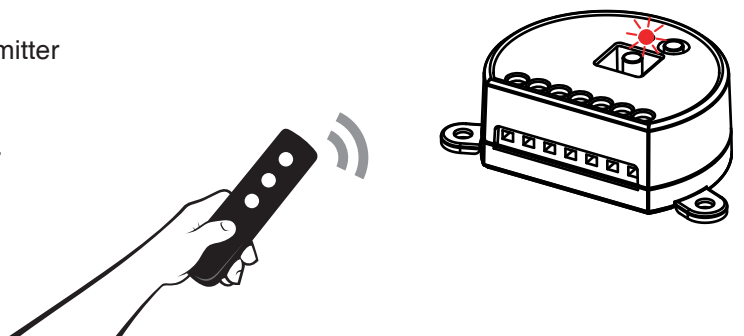

**AZIONE:** Short pressure    **LED:** Flashes 3 times



## 4.2 - DELETION OF REMOTE CONTROL

These procedures let you delete from the memory transmitters that have already been programmed.

### STEP 1

Hold the receiver button RADIO down (about 8 seconds.) until the LED begins to Flash.

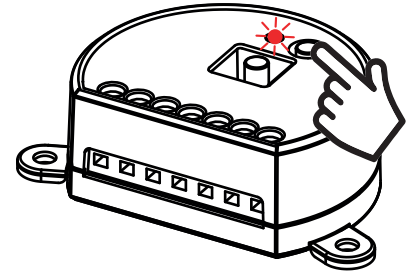

**ACTION:** Hold button RADIO down    **LED:** Flashes red

### DELETION OF SINGLE TRANSMITTER

### STEP 2a

Within 10 seconds make a transmission with the transmitter that you want to delete. The LED flashes quickly and turns off.

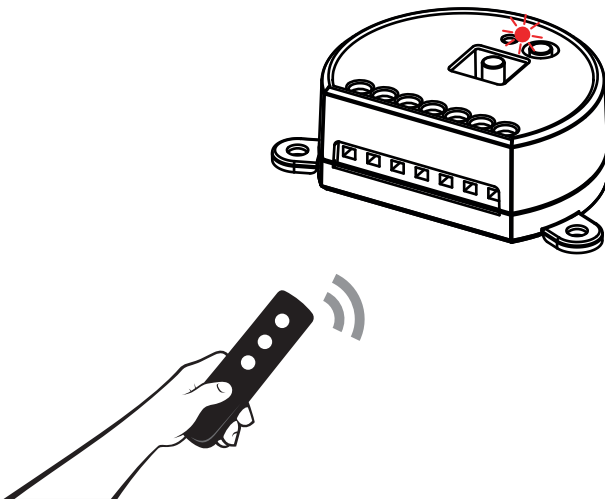

**ACTION:** Make a transmission with the transmitter  
**LED:** Flashing quickly and turns off

### DELETION OF ALL TRANSMITTER SAVED

### STEP 2B

Within 10 seconds press the button RADIO on the receiver for a short time to confirm the deletion of all transmitters. The LED starts Flashing quickly and turns off.

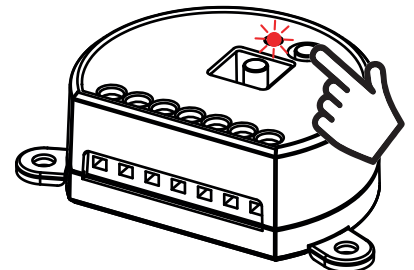

**ACTION:** Short press of button RADIO  
**LED:** Flashing quickly and turns off

## 5 - CONTROL WITH APP ONE SMART

These procedures allow you to manage the light from your device (example: mobile phone) through the application and to control the system remotely.

### 5.1 - APP CONNECTION

This procedure connects the control unit Plano-One to the application. It shall be repeated for each control unit on the installation.

ATTENTION: an internet-based wi-fi network is required for te operation.

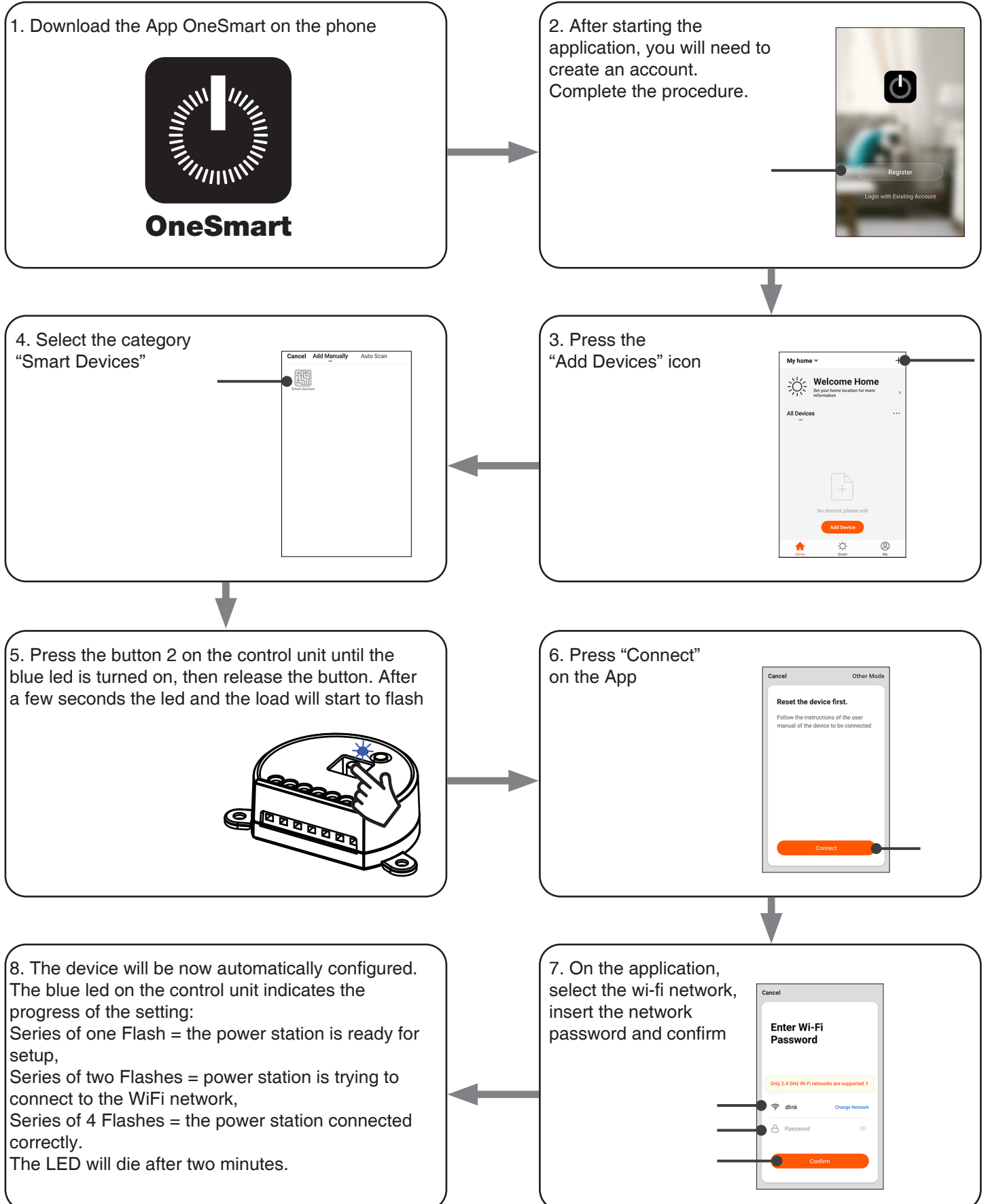

## 5.2 - USE OF THE APP ONE SMART

After all the control units have been set up, the installation can be managed by the application.

### USE

The “Home” menu (1) shows all the associated devices.  
To send a command to a device, select it.

Pressing “Smart” (2) allows you to add actions on your devices according to certain conditions and in certain time intervals, there are two types of actions:

- Automation (3): One or more actions happen if one or more conditions are satisfied
- Tap-to-Run (Scenario) (4): performs one or more actions by pressing an app button

#### EXAMPLES OF SCENARIOS (TAP-TO-RUN):

- Total off (switch off all the lights in the house)
- Scenario Soft (Dimming the desired lights at low intensity level)

#### EXAMPLES OF AUTOMATIONS:

- Hourly and weekly programmms
- Turn on the lights at the sunshine, turn off the lights at the sunrise.

Pressing “Me” (5) for entering to home and account settings.

From this menu, you can add members to the home for sharing device management or creating new houses.

#### PROCEDURE PFOR ADDING NEW USERS/MEMBERS.

1- From the “ME” menu (5), select “Home Management” (7) and then go to the house configurations and find “Add Member”

2- Insert the “OneSmart” account you want to add (email or mobile phone number of the new member), the new member will receive a notification of the invitation.

#### WARNING:

- The new user must have already downloaded the “OneSmart” application and created an account.
- Both the ‘administrator’ and the ‘new user’ must have set the same ‘region’ (Country).
- (Go to “Account (2)-Account and Security-Region” to view and change the set country).

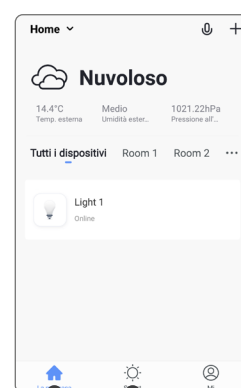

Home (1) Smart (2)

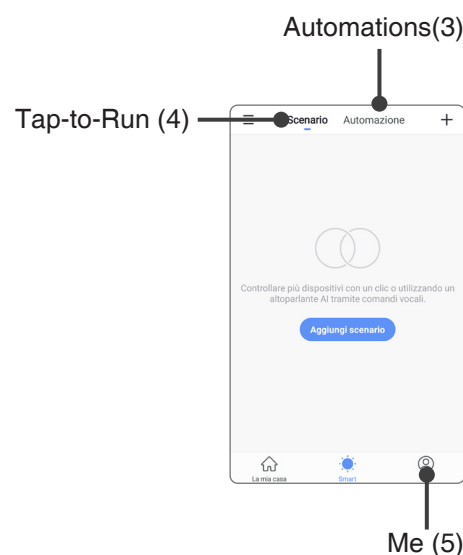

Automations(3)

Tap-to-Run (4)

Me (5)

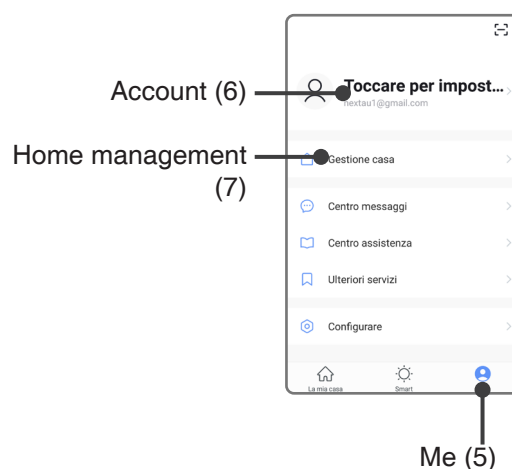

Account (6)

Home management (7)

Me (5)

## 6 - CONTROL BY VOICE COMMANDS

You can use this procedure to associate a “OneSmart” account with a Google or Alexa account to enable the voice commands.

### 6.1 - CONNECTION TO “GOOGLE HOME”

#### PROCEDURE

**WARNING:** before proceeding with this procedure, you must have set up the “OneSmart” account, see paragraph 6.

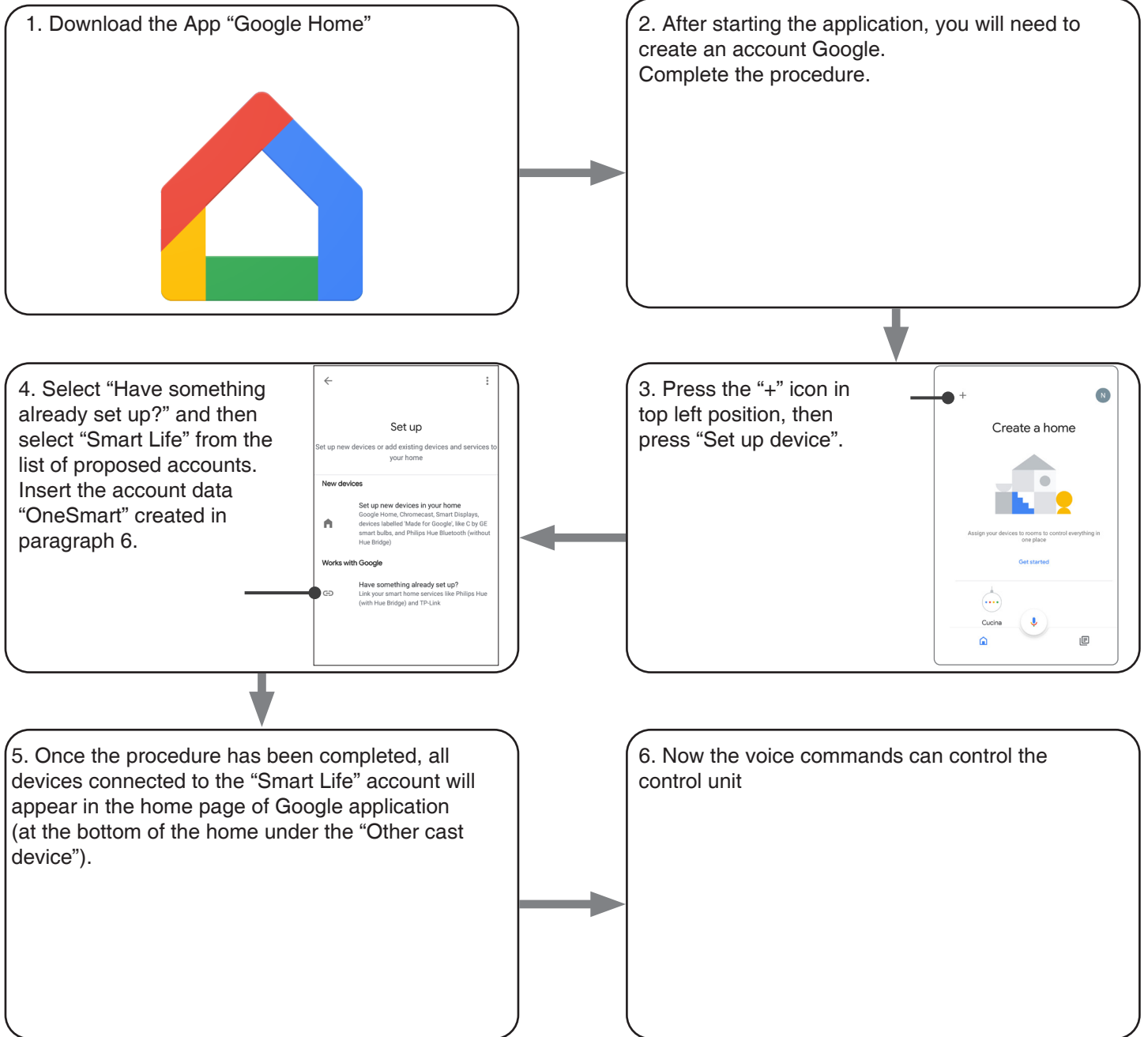

#### NOTES:

If you add other devices to your OneSmart application, they will automatically be added to the Google Home page. To use them with voice control, you need to add them to a room in the Google Home application, see step 6 of the procedure.

If devices are not added automatically, disconnect and reconnect your account from step 3 of this procedure from Google Home.

## USE OF “GOOGLE HOME”

### SENDING VOICE COMMANDS

Using your Android mobile phone (or tablet), voice commands can already be sent via the native assistant. By using an Apple device, you can use the microphone within the Google Home application. If you want to add a voice recognition device such as “Google Home Mini” or “Google Home”, follow the procedures to match it to the house you created and then they will be associated with the lights.

### VOICE COMMAND LIST

Here below there are some examples of dedicated voice commands for lights:

OK Google, Turn on / Turn Off \*name of the device\* or \*name of the room\*

OK Google, Turn on / Turn Off the lights

OK Google, turn off all the lights

### USE OF ROUTINES

The Nexta control unit is compatible with Google routine.

The Google Home application allows you to create some vocal commands to be associated with one action or sequence of actions.

This allows you to create scenarios, but also allows you to customize the command to get a certain action.

### EXAMPLES OF SCENARIOS

OK Google, Dark! Turn off all the lights

OK Google, Movie! Turn off some lights and soft dimming of other lights

### EXAMPLES OF CUSTOMIZED COMMANDS

OK Google, Dark! Turn off the light  
(corresponds to the native “Turn off \*light name\*” command)

## 6.2 - CONNECTION TO “AMAZON ALEXA”

### PROCEDURE

**WARNING:** before proceeding with this procedure, you must have set up the “OneSmart” account, see paragraph 6.

1. Download the App “Amazon Alexa”



2. After starting the application, you will need to create an account Amazon. Complete the procedure.

3. From the application home page press “menu” (1) then “Skill and games” (2). Press on the “Magnifying glass” at the top right and then search for “Smart Life” (3). Follow the procedure to enable use of the “OneSmart” account created using paragraph 6

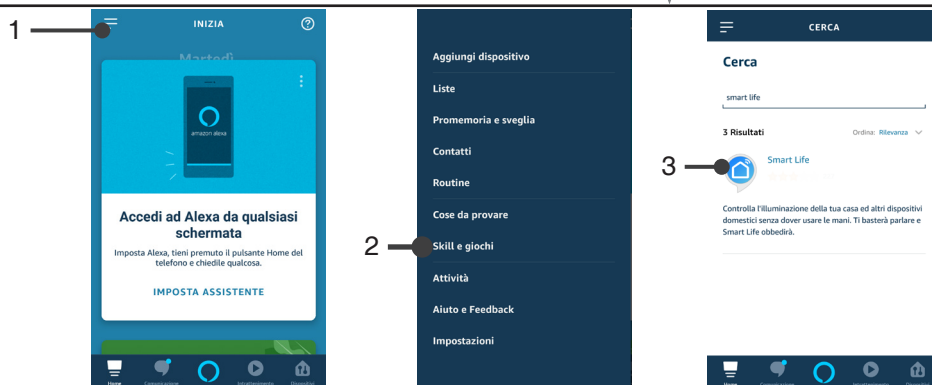

4. Complete the procedure by entering the “OneSmart” account data created in paragraph 6. You can then start searching for devices by pressing the “Discover devices” button (4). If you want, complete the setting-up procedure by inserting the device into a room.

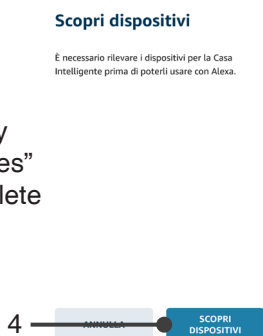

5. Now the voice commands can control the control unit

## **USE OF “AMAZON ALEXA”**

### **SENDING VOICE COMMANDS**

Using your Android mobile phone (or tablet), voice commands can already be sent via the Amazon Alexa application. Using an Apple device, you can use the microphone inside the Amazon Alexa application. If you want to add a voice-control device like “Echo Dot” or “Echo Plus”, follow the procedures to match it to the house you created, and then they will be associated with the lights.

### **EVOICE COMMAND LIST**

Here below there are some examples of dedicated voice commands for lights:

Alexa, Turn on / Turn Off \*name of the device\* or \*name of the room\*

Alexa, Turn on / Turn Off the lights

## 7 - ADVANCED PROGRAMS

### 7.1 - SETTING ADJUSTABLE MINIMUM BRIGHTNESS

Default: 20%

This procedure allows you to set the minimum level of brightness at which it is possible to adjust the load. The minimum level of brightness accepted at switch-on and dimming depends on the type of load connected.

#### STEP 1

Press and hold buttons RADIO and WIFI simultaneously, the LED is cyclically green and blu. Release the key when the led is green.

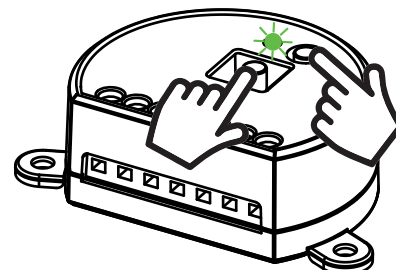

**ACTION:** Long press of buttons RADIO e Wi Fi **LED:** Turns on green/blu

#### STEP 2

Press the button RADIO on the receiver for a short time. The led starts to Flash.

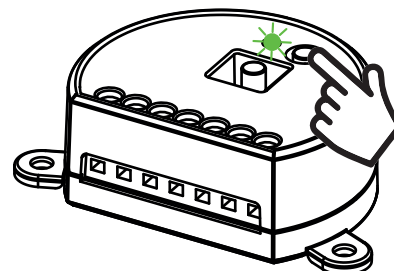

**ACTION:** Short pressure RADIO button **LED:** Flash

#### STEP 3

With the wired input or transmitter or app, set the desired minimum brightness

#### STEP 4

Press the button RADIO on the receiver for a short time. The led turns off.

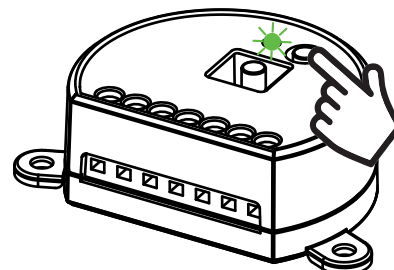

**ACTION:** Short pressure RADIO button **LED:** Turns off

\* if the light is set to off, the default minimum intensity value is reset.



## 7.2 - FUNCTION CUSTOMIZATION OF THE “WIRELESS BUS” GENERIC TRANSMITTER BUTTONS

The following procedure allows you to set a custom function to the “wireless bus” family transmitter button.

GENERIC RADIOTRANSMITTERS (WIRELESS BUS), CODES:  
HB80-6G, MCU-TX4, TOUCH-1G, TOUCH-2G, TOUCH-4G, TOUCH-LOCK4, TOUCH-TX2, ROUND-1G

### PROCEDURE

#### STEP 1

Press the button 1.  
The led turns on red.

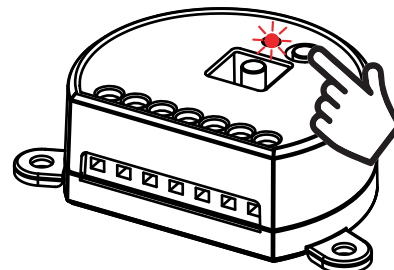

**ACTION:** Short press of button 1 **LED:** Turns on red

#### STEP 2

Press the button 2 on the receiver for a short time and count the number of Flashes emitted by the LED:

NUMBER OF FLASHES	FUNCTION
1	On
2	Off
3	On (short) / Dimmer Up (long)
4	Off (short) / Dimmer Down (long)
5	Dimmer Up
6	Dimmer Down
7	On/Off

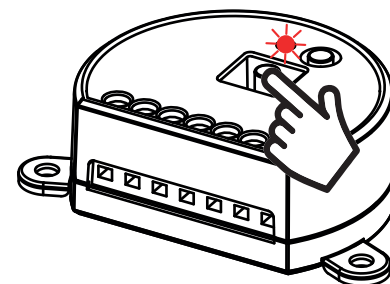

**ACTION:** Short press of button Wi Fi  
**LED:** Count the number of Flashes

#### STEP 3

Press the button Wi Fi for a short time during the Flash that corresponds to the function desired to end the count.  
The led stop Flashes

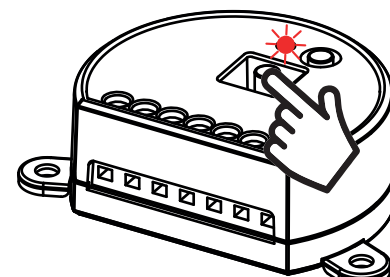

**ACTION:** Short pressure of button Wi Fi during the Flash **LED:** Stop Flashes

#### STEP 4

Make a transmission with the transmitter to be saved (see transmitter manual, paragraph entitled “transmitter programming”).  
The LED on the receiver Flashes 3.times and turns off.

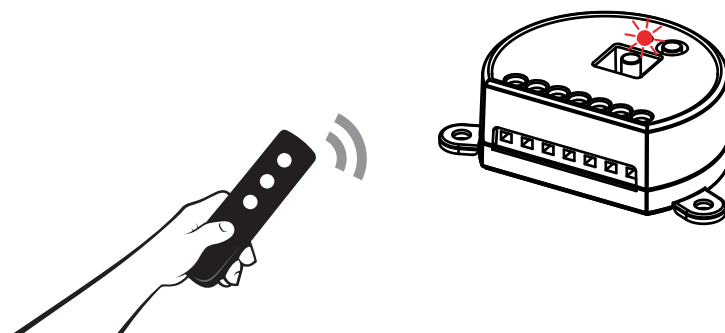

**ACTION:** Make a transmission with the transmitter **LED:** Flashes 3 times

### 7.3 - SETTING TIMING

Default: 18 hours

This procedure is used to set the time for which the Leds stays on before an automatic switch off.

All commands reset the time count to zero, excluding the following commands that will immediately turn off the light: short press by wired push button, command OFF by radiotransmitter, comand by App or voice.

#### PROCEDURE

##### STEP 1

Press and hold buttons RADIO and WIFI simultaneously.

The LED is cyclically green and blu.

Release the key when the led is green.

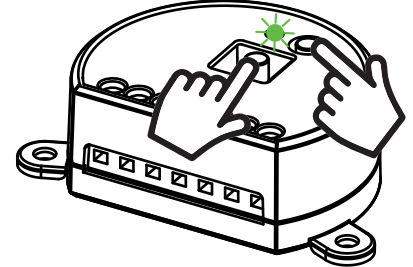

**ACTION:** Long press of buttons RADIO e Wi Fi **LED:** Green/Blu

##### STEP 2

Press the button WI FI on the receiver for a short time and count the number of Flashes emitted by the LED:

NUMBER OF FLASHES	FUNCTION
1	No timing
2	1 minute
3	5 minutes
4	15 minutes
5	30 minutes
6	1 hour
7	2 hours
8	3 hours
9	8 hours
10	12 hours
11	18 hours

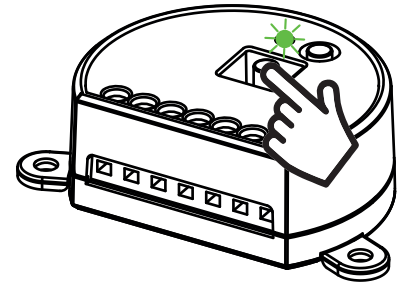

**ACTION:** Short pressure WI FI button **LED:** Flash

##### STEP 3

Press the button WIFI for a short time during the Flash that corresponds to the function desired to end the count.

The led turns off

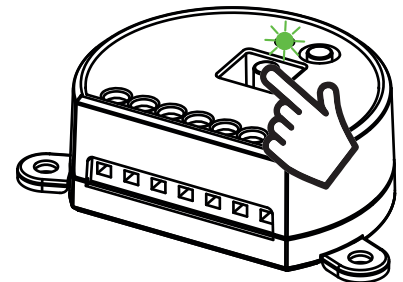

**ACTION:** Short pressure Wi Fi button **LED:** Turns off

## 7.4 - SETTING ADJUSTABLE MINIMUM BRIGHTNESS

Default: Last value before the black out

This process is used to set the state of Leds when the control unit is switched on (for example when the power supply is provided by a general switch or timer).

### PROCEDURE

#### STEP 1

Press and hold buttons RADIO and WIFI simultaneously, the LED is cyclically green and blu.

Release the key when the led is blu.

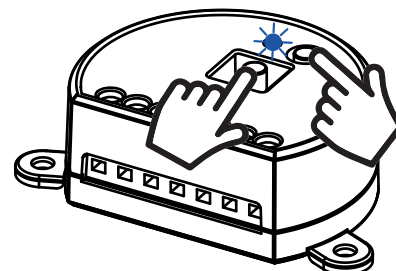

**ACTION:** Long press of buttons RADIO e Wi Fi **LED:** Turns on green/blu

#### STEP 2

Press the button RADIO on the receiver for a short time.

The led starts to Flash.

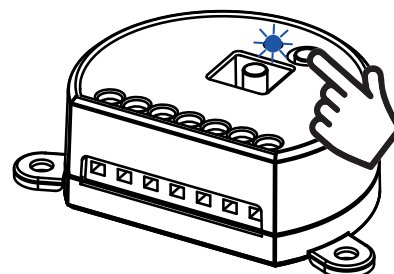

**ACTION:** Short pressure RADIO button **LED:** Flash

#### STEP 3

With the wired input or transmitter or app, set the desired brightness

#### STEP 4

Press the button RADIO on the receiver for a short time.

The led turns off.

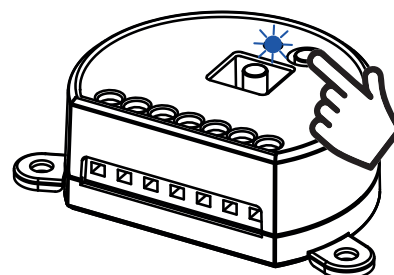

**ACTION:** Short pressure RADIO button **LED:** Turns off

\* if the light is set to off, the default is reset (last value)

## 7.5 - RESET OF THE CONTROL UNIT

This procedure let you take the control unit back to factory settings.

ATTENTION: the only parameter that will not be removed will be the association with the ONESMART application.  
To edit or delete also this parameter, reed the procedure.

### PROCEDURE

#### STEP 1

Hold the receiver button RADIO down (about 5 seconds.)  
until the LED begins to Flash.

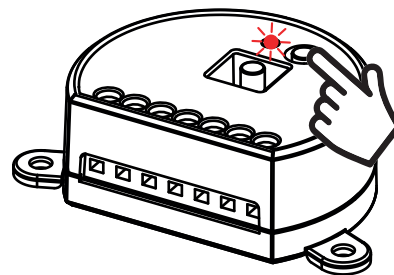

**ACTION:** Hold button RADIO down    **LED:** Flashes red



#### STEP 2

Within 10 seconds, make a short press of Wi Fi button.  
The LED 1 Flashes quickly and turns off.

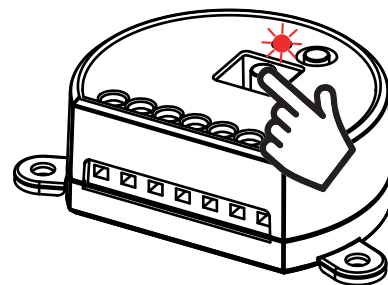

**AZIONE:** Short press of Wi Fi button    **LED:** the led Flash quicly and turns off









V1.0

**Nexta Tech**

company brand of Team srl  
via G.Oberdan 90, 33074  
Fontanafredda (PN) - Italy  
Ph. +39 0434 998682  
Email: [info@nexta-tech.com](mailto:info@nexta-tech.com)  
Web: [www.nexta-tech.com](http://www.nexta-tech.com)